

MONITOR WITH DVD RECEIVER
DDX5022/5022Y/5032
/5032M/512/52RY
DNX5120/512EX/5220/5220BT
SERVICE MANUAL

KENWOOD

Kenwood Corporation

© 2008-2 PRINTED IN JAPAN
 B53-0620-10 (N) 519

Illustrations is DNX5220BT

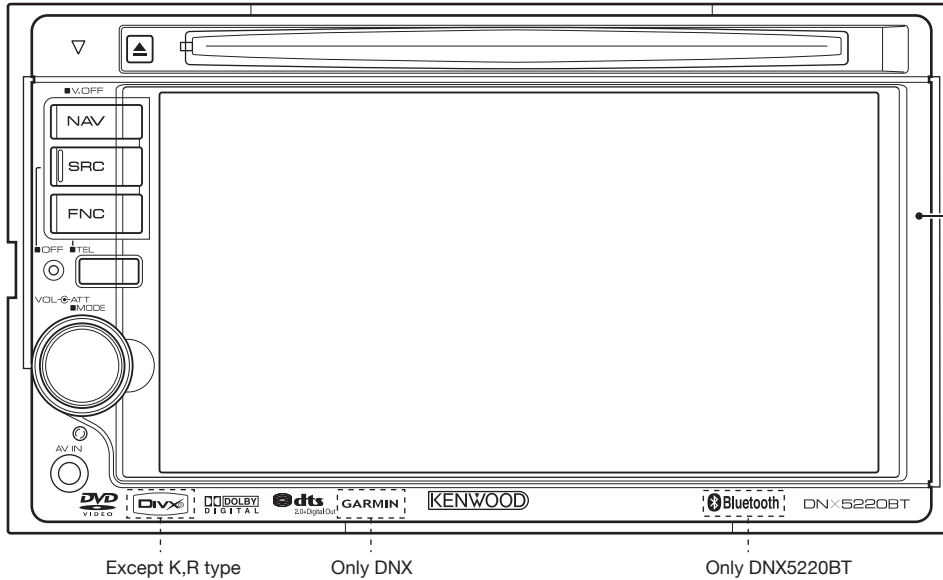

- Panel assy
 (A64-4530-11): DDX512
 (A64-4532-11): DDX5022/5022Y
 (A64-4535-11): DNX5120
 (A64-4536-11): DNX5220BT
 (A64-4537-11): DNX5220
 (A64-4539-01): DDX5032/5032M
 (A64-4540-01): DDX52RY
 (A64-4551-01): DNX512EX

Microphone *
 (W01-1718-05)



Remote controller *
 (A70-2083-15)



RC-DV340

Size AAA battery
 Not supplied



Escutcheon
 (B07-3165-02)

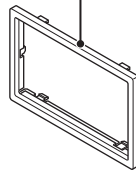

Mounting hardware assy
 (J22-0657-03)

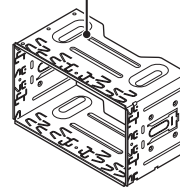

Lever
 (D10-4589-04) x2



DC cord *
 (E30-6796-05)

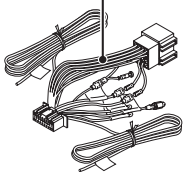

DC cord *
 (E30-6795-05)

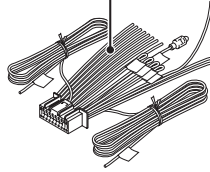

Adhesive double-coated tape *
 (H30-0595-04)



Escutcheon *
 (B07-3172-12)

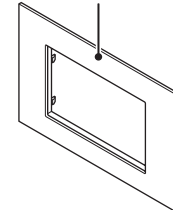

Cord with plug *
 (E30-6785-05)

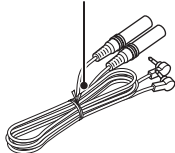

Antenna module(GPS-ANT)
 (W02-5305-05)

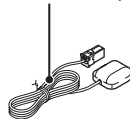

Mounting hardware *
 (J21-9867-04)

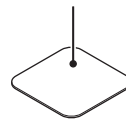

Screw set *
 (N99-1779-15)

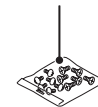

The IC3, and IC11 in the DVD unit (X37-1100-03) are not replaceable components.
 When these ICs are defective, replace the whole DVD mechanism assembly (X92-6160-00).
 You cannot replace only the board.

* Depends on the models. Refer to the parts list.

This product uses Lead Free solder.

This product complies with the **RoHS** directive for the European market.



GEAR POSITION IN A DVD MECHANISM

In assembling the Traverse UD arm, Drive cam assembly, Drive gear 5 and Drive gear 4C, align register marks on these components.

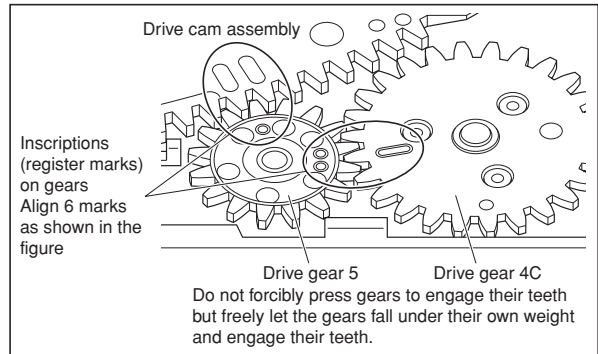
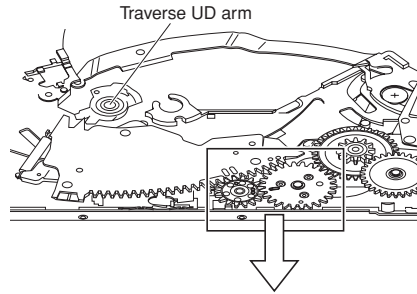

BLOCK DIAGRAM

DVS-8000V BLOCK DIAGRAM (X37-1100)

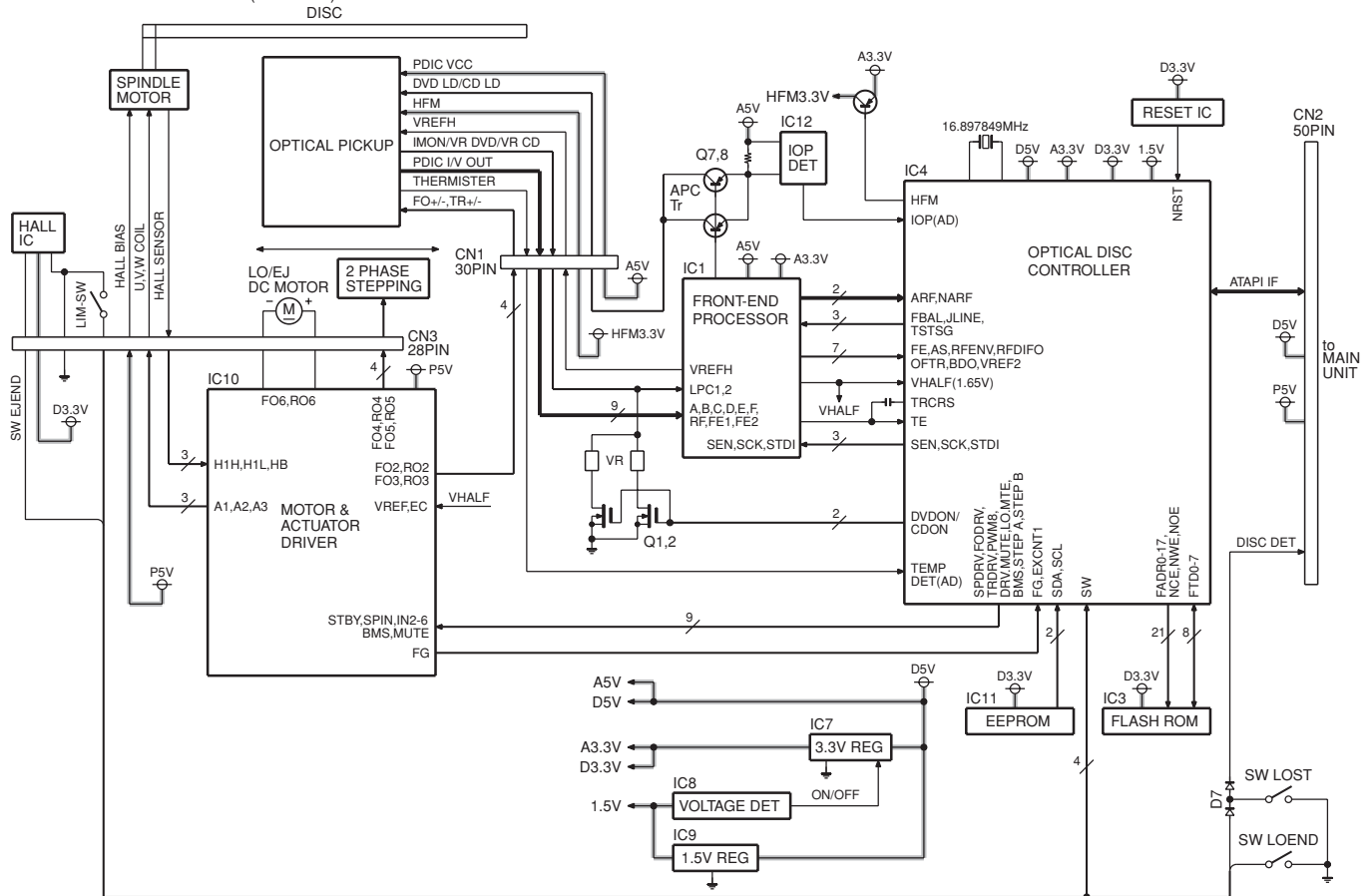

BLOCK DIAGRAM

DDX5022/5022Y/5032/5032M/512/52RY
 DNX5120/512EX/5220/5220BT

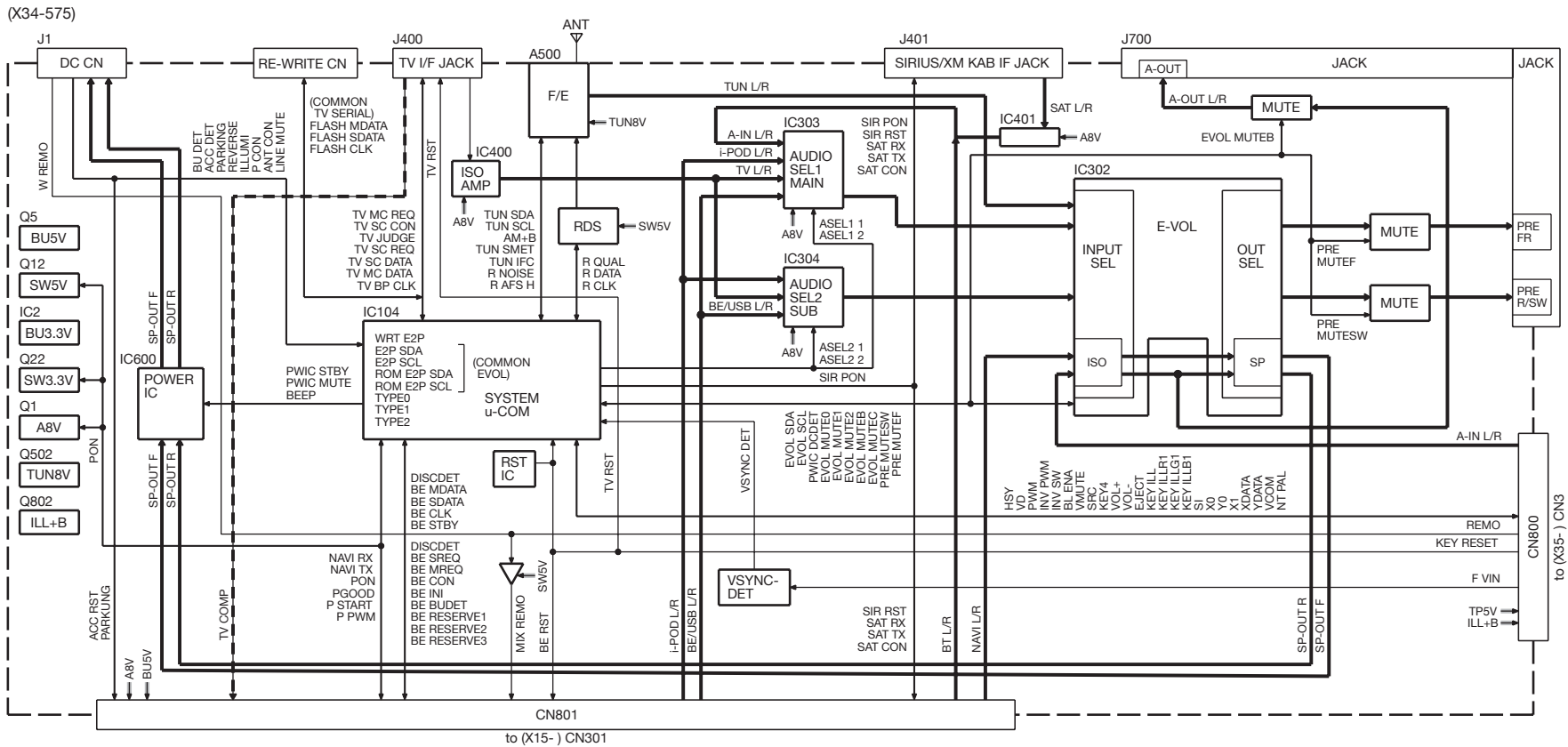

to (X15-) CN301

(X34-575)

BLOCK DIAGRAM

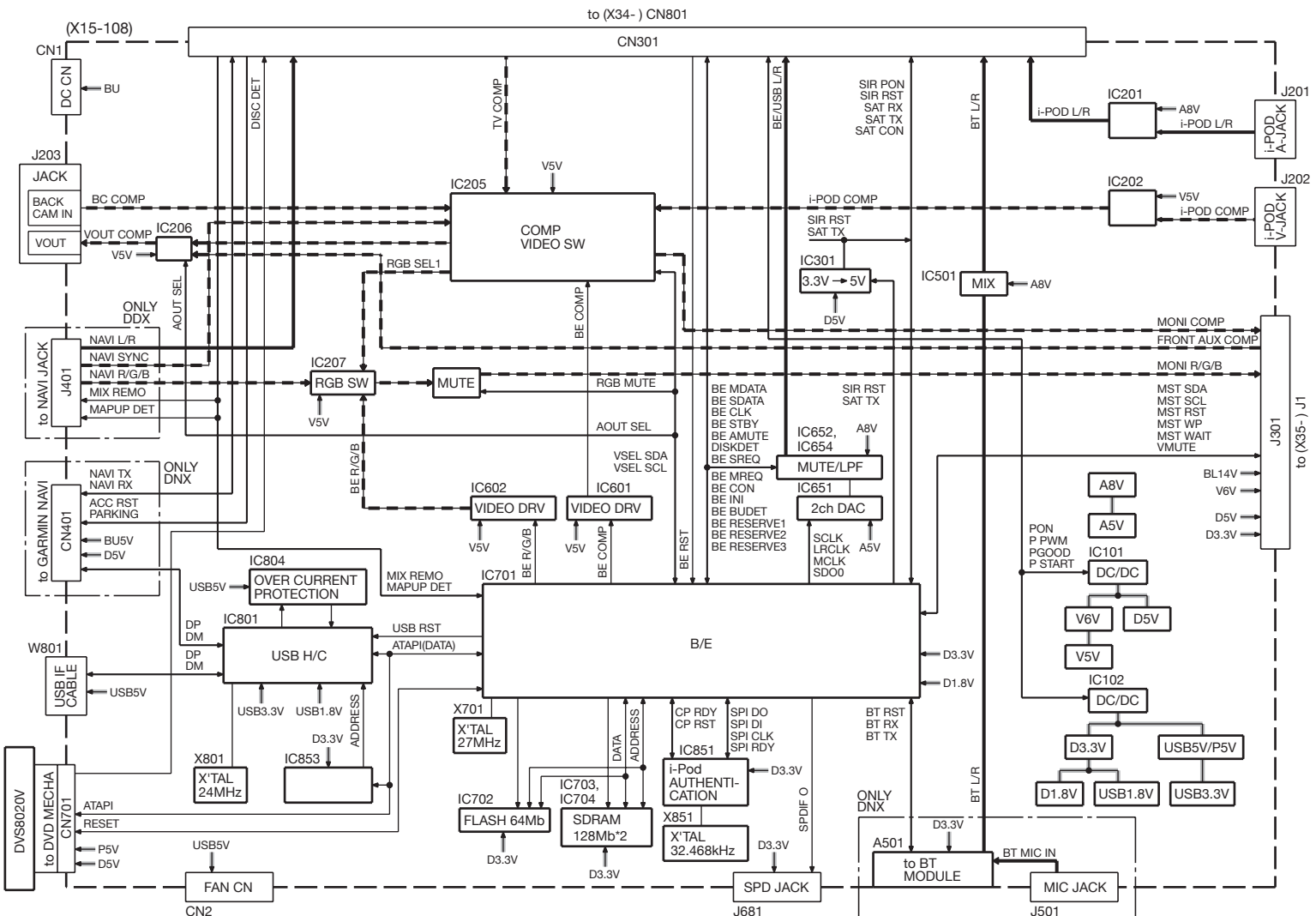

BLOCK DIAGRAM

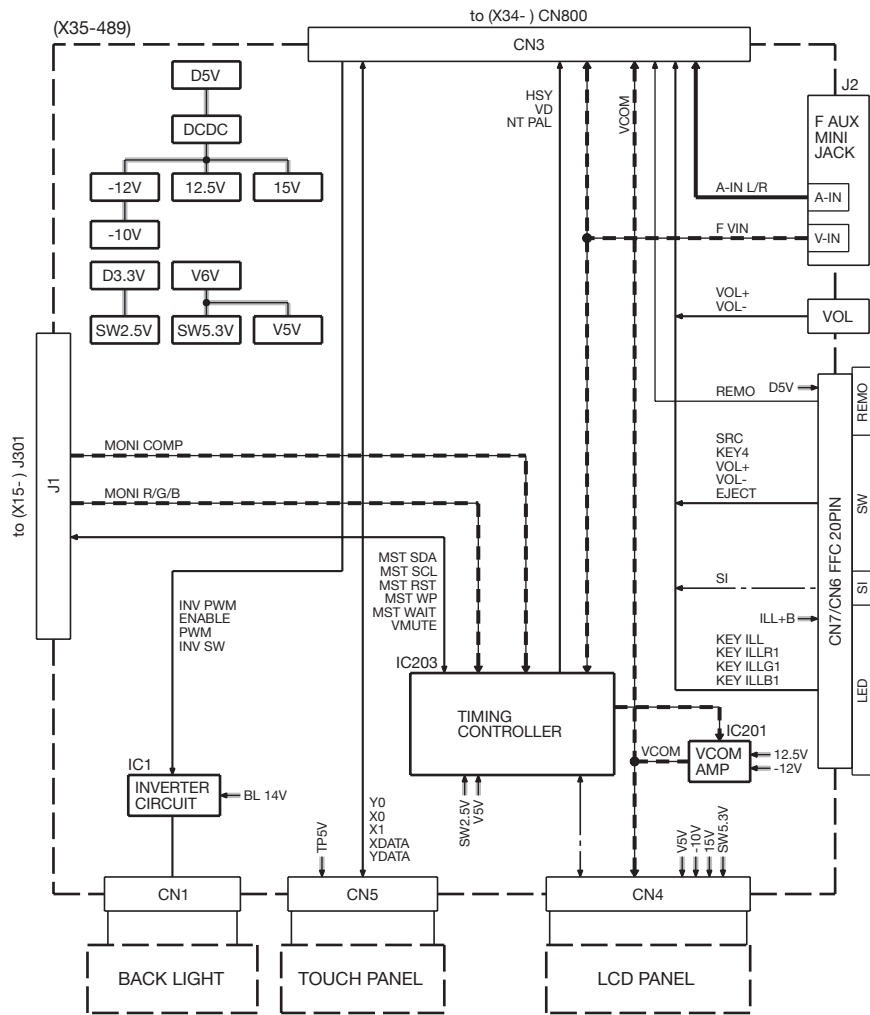

COMPONENTS DESCRIPTION

● VIDEO CONTROL UNIT (X15-108x-xx)

Ref. No.	Application / Function	Operation / Condition / Compatibility
IC100	DC/DC converter IC	DC/DC control for USB5V/D5V
IC101	DC/DC converter IC	DC/DC control for SW3.3V/V6V
IC201	AUDIO ISO AMP	iPod audio signal
IC202	VIDEO ISO AMP	iPod video signal
IC203	Regulator	V6V→V5V regulator
IC205	Video selector	5IN 2OUT DVD-BE/NAVI/TV/Ipod/BackCamera COMPOSITE signal Select
IC206	Video selector	Selector for selecting FRONT AUX output or IC205 output for external video output
IC207	Video selector	DVD-BE and NAVI RGB selector
IC301	AND x 4	KAB IF 3.3V→5V LEVEL SHIFT
IC501	OP-AMP X 2	LPF for BT-AUDIO
IC502	BUS BUFFER X 2	BUFFER for BT control signal wave shaping
IC601	Video amplifier	DVD-BE COMPOSITE SIGNAL LPF/BUFFER
IC602	Video amplifier	DVD-BE RGB SIGNAL LPF/BUFFER
IC651	AUDIO DAC	DVD-BE AUDIO D/A CONVERTER
IC652	OP-AMP X 2	DVD-BE AUDIO LPF
IC653	Regulator	Regulator for 8.4V→A5V AUDIO DAC
IC654	OP-AMP X 2	For AUDIO REFERENCE4V
IC691	INVERTER	SPDIF OUT BUFFER
IC692	AND	For DVD-BE IC RESET signal
IC701	MPEG DECODER	DVD/USB MPEG DECODER
IC702	64M FLASH	FLASH MEMORY(PMP 4Z3 / MP 4Z4) for MPEG DECODER
IC703,704	128M SDRAM	SDRAM for MPEG DECODER
IC705	Regulator	3.3V→1.8V regulator for MPEG DECODER
IC801	USB HOST CONTROLLER	2 ports (For external and GARMIN NAVI) USB HOST CONTORLLER
IC804	Fixed Current Limit Power Distribution Switch	Large current distribution switch for USB
IC805	Regulator	5V→3.3V regulator for USB
IC806	Regulator	SW3.3V→1.8V regulator for USB
IC851	iPod Authentication Coprocessor	iPod Authentication
IC853	D-TYPE LATCH X 8	Address latch for USB H/C
Q1~3	SW	P-ON 14V control
Q4	SW FET	P-ON 14V ON/OFF
Q100~103	SW	DC/DC protection control
Q104	SW	DC/DC SW FET (USB5V)
Q105	SW	DC/DC SW FET (D5V)
Q106	SW	DC/DC SW FET (SW3.3V)

COMPONENTS DESCRIPTION

Ref. No.	Application / Function	Operation / Condition / Compatibility
Q107	SW	DC/DC SW FET (V6V)
Q202	BUFFER	RGB signal R
Q203	BUFFER	RGB signal G
Q204	BUFFER	RGB signal B
Q205	SW	RGB signal MUTE R
Q206	SW	RGB signal MUTE G
Q207	SW	RGB signal MUTE B
Q301,302	SW	KAB_RX error connection protection
Q303	SW	For KAB_TX control
Q651	SW	DVD AUDIO MUTE L-CH
Q652	SW	DVD AUDIO MUTE R-CH
Q653,654	SW	DVD AUDIO MUTE control
Q681	BUFFER	SPDIF OUTPUT BUFFER

● ELECTRIC UNIT (X34-575x-xx)

Ref. No.	Application / Function	Operation / Condition / Compatibility
IC1	3-terminal regulator	For Audio8V
IC2	3.3V regulator	BU_3.3V
IC100	Buffer for remote controller	Remote controller signal waveform shaping
IC101	Voltage detector	μ-com reset voltage (3.5V) monitoring
IC103	E2PROM	For saving the settings
IC104	System μ-com IC	System control
IC105		NAVI interface waveform conversion (3.3 → 5V)
IC302	Electronic volume IC	Audio volume control and audio signal selection
IC303	Logic IC (multiplexer)	Audio signal selection (Main)
IC304	Logic IC (multiplexer)	Audio signal selection (Sub)
IC400	AUDIO ISO AMP	For TVBOX audio signal
IC401	AUDIO ISO AMP	For KAB audio signal
IC402	Logic IC (inverter)	TVBOX data signal waveform shaping
IC500	RDS decoder IC	For RDS signal processing and demodulation
IC600	Power IC	Power amplifier for speaker output
Q1,2	Transistor	Audio8V
Q3,4	Transistor	P_CON output circuit
Q5	Transistor	BU5V
Q6	Transistor	Reverse detection circuit
Q7	Transistor	Audio8V
Q8	Transistor	BU5V

COMPONENTS DESCRIPTION

Ref. No.	Application / Function	Operation / Condition / Compatibility
Q9	Transistor	P_CON output circuit
Q10	Transistor	Parking detection circuit
Q11	Transistor	P_CON output circuit
Q12	Transistor	SW5V circuit
Q13	Transistor	ILLUMI detection circuit
Q14	Transistor	ANT_CON output circuit
Q15	Transistor	SW5V circuit
Q16	Transistor	ANT_CON output circuit
Q17	Transistor	BU detection circuit
Q20	Transistor	Surge detection circuit
Q21,22	Transistor	SW3.3V circuit
Q23	Transistor	ACC detection circuit
Q24,25	Transistor	SW14V circuit
Q100-102	Transistor	ACC detection/KEY RESET
Q103,104	Transistor	DET MUTE circuit (Trigger Bu-DET)
Q105	Transistor	DET MUTE circuit (Trigger Reset)
Q107	Transistor	TVBOX RESET
Q108	Transistor	DET MUTE circuit (Trigger Bu-DET)
Q110	Transistor	SI
Q111	Transistor	Synchronizing separator circuit of FRONT VIDEO input
Q112	Transistor	SI
Q113-118	Transistor	Synchronizing separator circuit of FRONT VIDEO input
Q300	Transistor	Electronic volume IC MUTE
Q301	Transistor	For AUDIO selector
Q303-305	Transistor	For AUDIO selector
Q403	Transistor	KAB power supply
Q406	FET	KAB power supply
Q407	Transistor	KAB detection
Q500-503	Transistor	TUNER8V circuit
Q504,505	Transistor	On when AM (Tuner 8V)
Q700	Transistor	Pre-OutMute circuit (AV-OUT)
Q701	Transistor	Pre-OutMute circuit (REAR, SUB)
Q702-705	Transistor	Pre-OutMute circuit (FRONT)
Q706-708	Transistor	Pre-OutMute circuit (REAR, SUB)
Q709-711	Transistor	Pre-OutMute circuit (AV-OUT)
Q800,801	Transistor	LED9V SW
Q802,803	Transistor	LED9V

COMPONENTS DESCRIPTION

Ref. No.	Application / Function	Operation / Condition / Compatibility
Q804	Transistor	X15 SW-REG PSTART

● VIDEO UNIT (X35-4890-10)

Ref. No.	Application / Function	Operation / Condition / Compatibility
IC1	Inverter control IC	Control and drive of the inverter circuit for the back light
IC101	NOT	Reverse
IC102	DC/DC converter IC	+12.5V/-12.0V power supply for VCOM amplifier and +15.0V power supply for LCD
IC200	Regulator	2.5V regulator
IC201	Op-amp	For VCOM amplifier
IC202	D flip flop	LCD dot clock timing
IC203	γ T/C	Control of LCD module
IC204	OR	For V_MUTE
IC205	Regulator	5.3V regulator
IC206	Buffer	5V→3.3V level conversion
IC207	FROM	For Mstar FW
IC208	Regulator	5.3V regulator
IC501	AND	3.3V→5V level conversion
IC700	Remote controller photoreceptor	Detection for remote controller
Q1	5V constant voltage	5V power supply for inverter control IC
Q2	Dimmer SW	Turn on or off in response to the PWM control signal to dimmer the back light
Q3	SW	SW to change the free run frequency for inverter control IC
Q4,5	Inverter Driver	Drive of the inverter circuit
Q100	-10V regulator	LCD-10V regulator
Q101	-10V regulator control	LCD-10V regulator
Q201,202	Buffer	For VCOM current amplification
Q400	Buffer	CVBS2
Q401	Buffer	CVBS1
Q450	SW	SW to be turned on or off by NTSC/PAL signal and to change the filter constants
Q451	Buffer	For VCOM automatic adjustment
Q500	Touch panel X0 SW	X0 SW: Turn on in response to X axis input and apply voltage
Q501	Touch panel Y0 SW	Y0 SW: Turn on in response to Y axis input and apply voltage
Q502	Touch panel X1 SW	X1 SW: Turn on in response to detection of the panel touch or X axis input and apply voltage
Q503	Touch panel Y0/Y1 SW	Y0/Y1 SW: Turn on in response to Y axis input and turn off in response to X axis input
Q504	Touch panel Y0 SW	Y0 SW: Turn on in response to Y axis input and apply voltage
Q600	SW	RGB_LED SW (green)
Q601	SW	RGB_LED SW (red)
Q602	Buffer	AUX

COMPONENTS DESCRIPTION

Ref. No.	Application / Function	Operation / Condition / Compatibility
Q603	SW	RGB_LED SW (blue)
Q604	SW	LED SW (EJECT,DISC)
Q606	SW	5V→3.3V level conversion

● DVD UNIT (X37-1100-03)

Ref. No.	Application / Function	Operation / Condition / Compatibility
IC1	RF signal processing IC	RF signal processing
IC3	FLASH ROM	Maintain F/W for optical DISC control IC
IC4	Optical disc control IC in μ -com	Optical DISC general control / ATAPI interface
IC5	Voltage detection IC	For system resetting of optical DISC control IC
IC7	3.3V power supply	5V→3.3V
IC8	Voltage detection IC	For 1.5V power supply IC voltage monitor
IC9	1.5V power supply	5V→1.5V
IC10	Driver IC	Focus coil, Tracking coil, Spindle motor, Sled motor and Lo/Ej motor drive
IC11	EEPROM	Maintain data for optical DISC control IC
IC12	OP-AMP for IOP measurement	For IOP measurement
Q1	Register integrated transistor	SL. MUTE control
Q2	Register integrated transistor	For FG signal
Q3	Register integrated transistor	LO.MUTE control
Q4	Register integrated transistor	DRMU control
Q5	MOS-FET	Laser diode ON/OFF control for DVD
Q6	MOS-FET	Laser diode ON/OFF control for CD
Q12	Transistor for APC	Laser diode brightness control for CD
Q13	Transistor for APC	Laser diode brightness control for DVD
Q14	MOS-FET	For IOP measurement
Q15	Register integrated transistor	HFM ON/OFF control
Q18,19	Register integrated transistor	3.3V power supply IC ON timing control

MICROCOMPUTER'S TERMINAL DESCRIPTION

● SYSTEM MICROCOMPUTER 30878MJBA21GP (X34-575: IC104)

Pin No.	Pin Name	I/O	Application	Processing / Operation / Description
1	EVOL_SDA/EVOL_SDA	I/O	Communication data with E-VOL	
1	EVOL_SDA/E2P_SDA	O	Communication data with E2P	
2	TV_MC_REQ	O	Request to TV μ -com	
2	NC	O	Output from model without TV is fixed to "L"	
3	TV_SC_CON	O	Request to start TV μ -com	
3	NC	O	Output from model without TV is fixed to "L"	
4	VSYNC_DET	I	Video external input detection	Detects if there is VSYNC signal or not
5	VOL+	I	Detects VOL key	Detects pulse width 15 pulses/360°, 2 clicks, 1 pulse
6	VOL-	I	Detects VOL key	Detects pulse width 15 pulses/360°, 2 clicks, 2 pulse
7	HSY	I	HD input	Counts HD
8	VD	I	VD (VSYNC) input	
9	SRC	I	Source key	
10	TV_SC_REQ	I	Request from TV μ -com	
10	NC	O	Output from model without TV is fixed to "L"	
11	REVERSE	I	Reverse detection	L: Detection, H: Normal
12	PWIC_STBY	O	Power IC standby	H: ON, L: OFF
13	INV_PWM	O	Inverter frequency control (Output by timer)	
14	PWIC_MUTE	O	Power IC output mute control	H: OFF, L: ON
15	BYTE			
16	CNVSS			
17	XCIN			
18	XCOU			
19	RESET			
20	XOUT			
21	VSS			
22	XIN			
23	VCC1			
24	NMI			
25	ACC_DET	I	ACC detection	H: ACC reduced power detection
26	BU_DET	I	Backup power supply detection	H: Backup reduced power detection
27	R_CLK	I	Clock input from RDS decoder	
27	NC	O	Output from model without RDS is fixed to "L" (To destination X and V)	
28	NC	O		
29,30	NC	O		Not used. Output is fixed to "L"
31	PWM	O	LCD brightness control (PWM output)	PWM output synchronized with VSY
32	PARKING	I	Parking detection (For all the destinations)	H: Detection, L: When car is running
33	BEEP	O	BEEP	PWM output
34	NC	O		
35	POWER_PWM	O	Frequency control of DC-DC_IC (CLK output)	
36	NAV_RX	I	Communication with navigation system	
37	NAVI_TX	O	Communication with navigation system	
38	TV_MC_DATA	O	Data output to TV μ -com	

MICROCOMPUTER'S TERMINAL DESCRIPTION

Pin No.	Pin Name	I/O	Application	Processing / Operation / Description
38	NC	O	Output from model without TV is fixed to "L"	
39	VCC1			
40	TV_SC_DATA	I	Data input from TV μ -com	
40	NC	O	Output from model without TV is fixed to "L"	
41	VSS			
42	TV_BP_CLK	O	Communication clock with TV μ -com	
42	NC	O	Output from model without TV is fixed to "L"	
43	NC	O		
44	TUN_SDA	I/O	Communication data with tuner	
45	TUN_SCL	O	Communication clock with tuner	
46	R_DATA	I	"DATA" input from RDS decoder	
46	NC	O	Output from model without RDS is fixed to "L"	
47	R_QUAL	I	"QUAL" input from RDS decoder	
47	NC	O	Output from model without RDS is fixed to "L"	
48~51	NC	O		
52	SI	O	SI control	H: ON, L: OFF
53,54	NC	O		
55	TYPE3	I	Terminal for destination (BT is required or not)	H: With BT, L: Without BT
56	VILL_R	O	Brightness control of "R" in variable illumination	Operating frequency: 1kHz
57	VSS			
58	VILL_G	O	Brightness control of "G" in variable illumination	Operating frequency: 1kHz
59	VCC2			
60	VILL_B	O	Brightness control of "B" in variable illumination	Operating frequency: 1kHz
61	KEY_ILL	O	ON/OFF of other illumination than variable illumination	H: ON, L: OFF
62	EJECT	I	Eject key input	
63	Y0	O	Touch panel control	
64	X1	O	Touch panel control	
65	NC	O		
66	X0	O	Touch panel control	
67	INV_SW	O	Inverter free run frequency switching	
68	BL_ENA	O	Back light ON/OFF control	H: ON, L: OFF
69	VMUTE	O	Video MUTE terminal	H: MUTE ON, L: MUTE OFF
70	NT_PAL	I	NTSC/PAL determination signal input	H: NTSC, L: PAL
71	P_START	O	DC-DC power supply ON/OFF control	
72	PGOOD	I	DC-DC power supply error detection	H: Normal, L: Error
73	WRT_E2P	I	Used when writing into E2P	L: Normal condition H: When writing into E2P
74	VCC2			
75	NC	I	Variable illumination identification terminal (Spare)	Input (Not used)
76	VSS			
77	NC	O	Not used. Output is fixed to "L"	
78	DISKDET	I	DVD mechanism function to detect if there is a disc or not	H: Disc is not detected, L: Disc is detected
79	BE_MREQ	O	Request to back end	
80	BE_STBY	I	Standby request from back end	
81	BE_CON	O	Control request to back end	

MICROCOMPUTER'S TERMINAL DESCRIPTION

Pin No.	Pin Name	I/O	Application	Processing / Operation / Description
82	BE_INI	O	Initial request to back end	
83	BE_BUDET	O	Notification of momentary power down detection to back end	
84	NC	O		
85	BE_RESERVE2	I	Operation identification terminal from back end	H: Valid, L: Invalid
86	BE_RESET	O	Reset request to back end	L: Reset, H: Clear reset
87	NC	O		
88	BE_SDATA	I	Communication data from back end	
89	BE_CLK	I	Communication clock with back end	
90	BE_MDATA	O	Communication data to back end	
91	VCC2			
92	TYPE1	I	Destination settings	Refer to "Destination settings"
93	VSS			
94	TYPE2	I	Destination settings	Refer to "Destination settings"
95	NC	O	Not used. Output is fixed to "L"	
96	ASEL2_2	O	AVOUT source audio switching	Refer to "ASEL settings"
97	ASEL2_1	O	AVOUT source audio switching	Refer to "ASEL settings"
98	ASEL1_2	O	Main source audio switching	Refer to "ASEL settings"
99	ASEL1_1	O	Main source audio switching	Refer to "ASEL settings"
100	EVOL_MUTE0	O	E-VOL front mute	L: ON, H: OFF
101	EVOL_MUTE1	O	E-VOL rear mute	L: ON, H: OFF
102	NC	O		
103	BE_RESERVE1	I	CLK terminal for operation identification from back end	CLK frequency: 1Hz
104	BE_SREQ	I	Request from back end	
105	EVOL_MUTE2	O	E-VOL R SW mute	L: ON, H: OFF
106	EVOL_MUTEC	O	E-VOL_C mute	L: ON, H: OFF
107	EVOL_MUTEB	O	E-VOL_B AVOUT mute	L: ON, H: OFF
108	AM+B	O	Tuner AM power supply ON/OFF control	L: ON, H: OFF
109	PRE_MUTEF	O	Pre-out mute (FRONT)	L: ON, H: OFF
110	PRE_MUTESW	O	Pre-out mute (REAR/SW)	L: ON, H: OFF
111	PON	O	SW power supply ON/OFF control	L: ON, H: OFF
112	SIR_DET	I	Sirius connection detection	
113	SIR_PON	O	SAT power supply ON/OFF	
114	NC	O		
115	TV_JUDGE	I	Determination of TV_BOX if it is old or new	H: Old, L: New
115	NC	O	Output from model without TV is fixed to "L"	
116	ANT_CON	O	Power antenna control	H: UP, L: DOWN
117	P_CON	O	P-CON control	L: STANDBY, POWER OFF, H: EXCEPT
118	ILLUMI	I	Illumination detection	L: ON, H: OFF
119~121	NC	O		
122	TYPE0	I	Destination settings	Refer to "Destination settings"
123	KEY3	I	Key3 input	Refer to "KEY3 matrix"
124	TUN_IFC	I	F/E IFC input	H: Station found, L: Station not found
125	TUN_SMET	I	S meter input	
126	R_NOISE	I	FM noise input	
127	R_AFS_H	I/O	Time constant switching when F/E noise is detected	

MICROCOMPUTER'S TERMINAL DESCRIPTION

Pin No.	Pin Name	I/O	Application	Processing / Operation / Description
128,129	NC	O		
130	VSS			
131	NC	O		
132	VCC1			
133,134	NC	I	Not used (Input)	
135	VILL_DET	I	Variable illumination identification terminal	L: F3, H: F4
136	VCOM	I	For VCOM level automatic adjustment	
137	X_DATA	I	Touch data input	
138	Y_DATA	I	Touch data input	
139	LINE_MUTE	I	LINE-MUTE input detection	Normal: 1.6V TEL MUTE: 1V or lower NAVI MUTE: 2.5V or higher
140	AVSS			
141	PWIC_DC_DET	I	SP output DC offset detection	L: When detected
142	VREF			
143	AVCC			
144	EVOL_SCL/EVOL_SCL	O	Communication clock with E-VOL	
144	EVOL_SCL/E2P_SCL	O	Communication clock with E2P	

Destination Settings

MODEL	Destination	TYPE2 (94)	TYPE1 (92)	TYPE0 (122)	TYPE3 (55)	Note
KVT	K	0	0	*	-	
	E	0	0	*	-	
	M	0	0	*	-	
	V/X	0	0	*	-	
	R	0	0	*	-	
DDX	K	0	1	*	0	
	E	0	1	*	0	
	M	0	1	*	0	
	V/X	0	1	*	0	
	R	0	1	*	0	
DNX	K	1	1	*	0	
	E	1	1	*	1	With BT, Without SAT
	E2	1	1	*	0	With BT, Without SAT

TYPE0 is AD input
 "*" Refer to the next table (TYPE0 Setup Voltage)
 E of TYPE0 should be same as E2 of TYPE0

TYPE0 Setup Voltage

Destination	μ-com setup value			Pull down resistor	Pull up resistor
	min	Mid point voltage	max		
K	0.00	0.00	0.41	10	-
E	0.42	0.83	1.23	3.3	10
M	1.24	1.65	2.06	10	10
V/X	2.07	2.48	2.88	30	10
R	2.89	3.30	3.30	-	10

MICROCOMPUTER'S TERMINAL DESCRIPTION

ASEL Set Up

	MAIN	
	ASEL1_1(99)	ASEL1_2(98)
BE	0	0
(TV)	0	1
IPOD	1	0
SAT or BT	1	1

Models for destination K and R do not have TV

	SUB	
	ASEL2_1(97)	ASEL2_2(96)
BE	0	0
(TV)	0	1
IPOD	1	0
-	1	1

Models for destination K and R do not have TV

In the model without TV, ASEL2_2 output is fixed to "L"
 ASEL3_1(95) output is fixed to "L"

KEY3 matrix

		MAX	MIN	
VCC	3.3	3.366	3.234	[V]
PULL UP in X34	15	15.75	14.25	[KΩ]
R1 in X35	0.01	0.0105	0.0095	[KΩ]
R2 in X35	6.8	7.14	6.46	[KΩ]
R3 in X35	18	18.9	17.1	[KΩ]

Calculated value

			MAX	MIN	
S601	ENTER*	Vs1=	0.002198534	0.002478384	0.001949491 [V]
S701	NAVI	Vs2=	1.0303989	1.124673863	0.941621684 [V]
S702	FNC	Vs3=	2.056593821	2.175803849	1.938574066 [V]
	Do not press		3.3	3.366	3.234 [V]

Set up μ -com in the following range of the settings

		MAX	MIN	
S601	ENTER*	0.5	0	[V]
S701	NAVI	1.5	0.51	[V]
S702	FNC	2.5	1.51	[V]
	Do not press	3.3	2.51	[V]

* ENTER KEY is the rotary VOL / Press KEY

KEY position

S701	NAVI
S703	SRC
S702	FNC

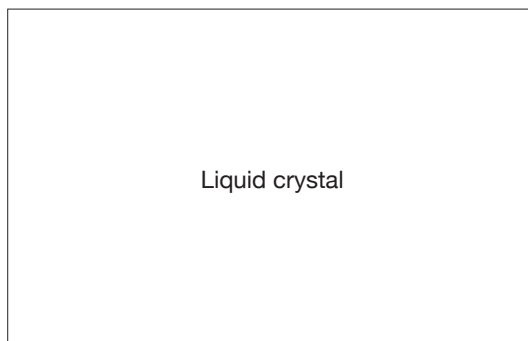
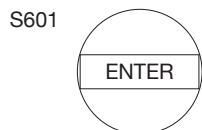

TEST MODE

1 Operations

The system can be transferred to the Test mode with the following two approaches:

- ① DNX/DDX : [SRC] key+[ATT] key
 KVT : [OPEN] key+[SRC] key
 While keep pressing the above key, press [Reset] key to start the system.
- ② In the standby source mode while the system is in the ON condition (in the normal condition), enter "2 → Seek Up → 3" with (SW: AUD) of the remote controller.

Turn the system OFF in 30 minutes when it is started in the Test mode.
 Do not display the Opening screen when the system is started in the Test mode.

2 Screen transition

The system is started with the Test Mode Main screen when it is started in the Test mode. When the system is transferred to the Test mode using the remote controller, it transfers to the Test Mode Main screen.
 A variety of screens that can be transferred from the Test Mode Main screen is shown in Figure 2.
 Refer to Section 3 for the functions in each screen.

3 Specification of screens

This section describes the Test mode functions available in each screen.

3.1 Test Mode Main screen

This section describes the keys that can be used to transfer to each screen.
 Contents of the display shown in the Test Mode Main screen are described in Figure 3.1.

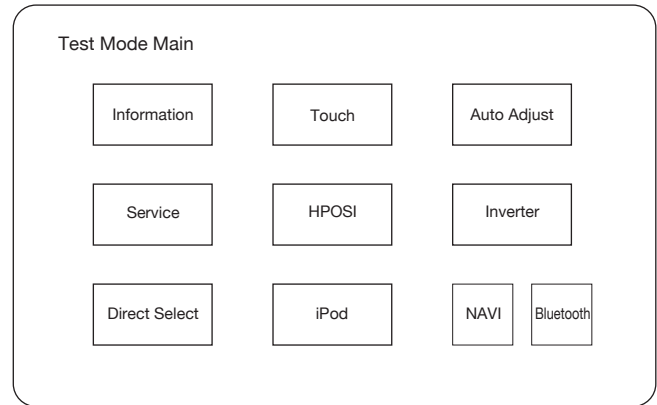

Figure 3.1 Test Mode Main screen

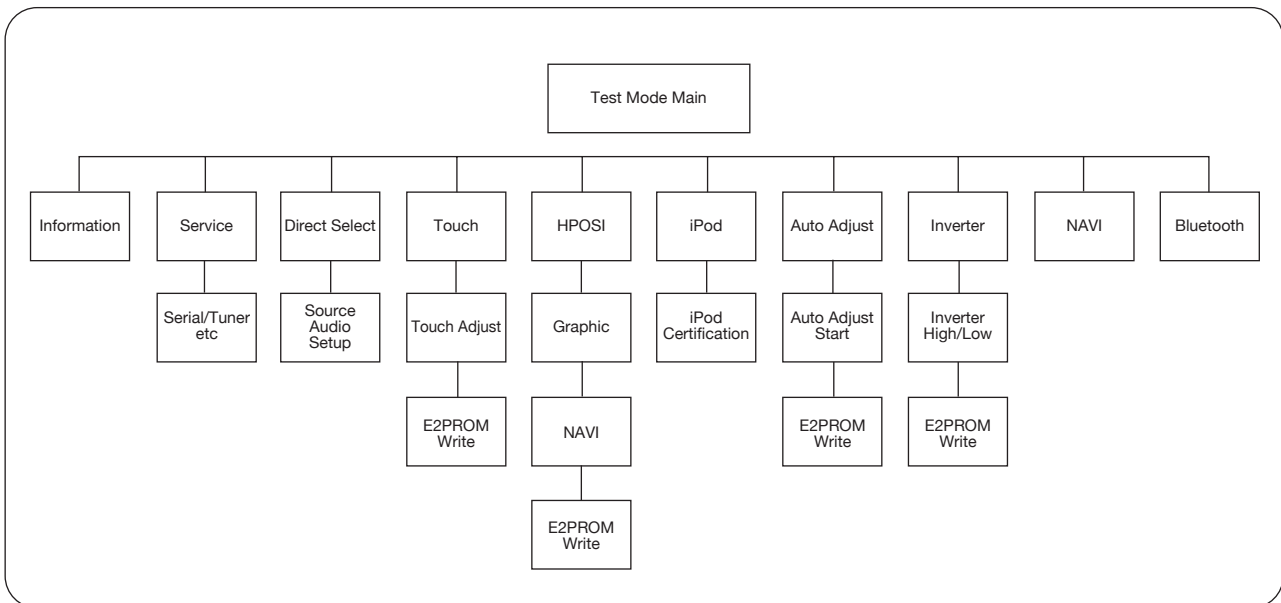

Figure 2 Screen transition

TEST MODE

Key Specification

- Information : Transfer to Information screen.
- Service : Transfer to Service screen.
- Direct Select : Transfer to Direct Select screen.
- Touch : Transfer to Touch Adjust screen.
- HPOSI : Transfer to HPOSI Adjustment screen.
- iPod : Transfer to iPod Authentication Chip Confirmation screen.
- Auto Adjust : Transfer to Auto Adjust Menu screen.
- Inverter : Transfer to Inverter Confirmation screen.
- NAVI : Transfer to Navigation MAP Update Confirmation screen.
- Bluetooth : Transfer to Bluetooth Confirmation screen (only in the system running on the production line).

3.2 Information screen

This screen is to display such information as version number and other conditions. The contents displayed on the Information screen are shown in Figure 3.2.

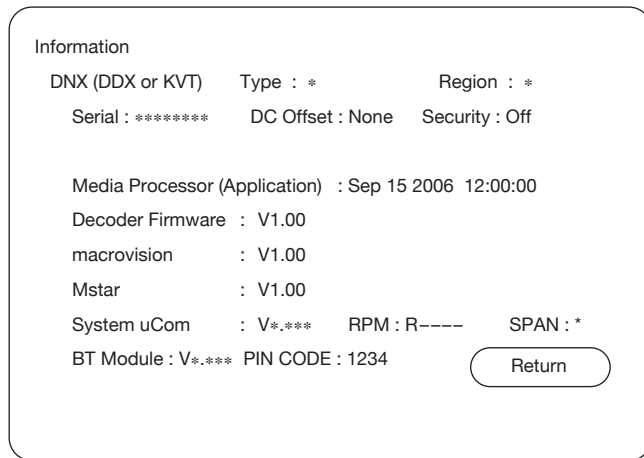

Figure 3.2 Information screen

Key Specification

- Return : Transfer to Test Mode Main screen

3.3 Service screen

This screen is to show a variety of service information. Pressing each [Clear] key is to clear the data saved in E2PROM. The contents displayed on the Service screen are shown in Figure 3.3.

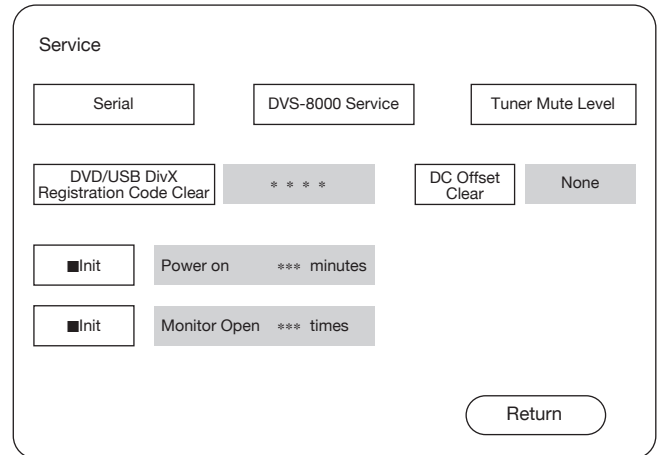

Figure 3.3 Service screen

Key Specification

- Serial : Transfer to the screen to manually input the Serial No.
- DVS-8000 Service: Transfer to DVS-8000 Service Information Display screen.
- Tuner Mute Level : Transfer to Tuner Mute Level Adjustment screen
- DVD/USB DivX Registration Clear : Clear DVD DivX Registration Code.
- DC Offset Clear : Clear DC Offset information in E2PROM.
- [Init] : Initialize Power On time and number of Monitor Open.
- Return : Transfer to Test Mode Main screen

- DVD/USB DivX Registration Code
 - Display DivX Registration Code, and clear the Code with [Clear] key.
 - After the clearing of the Code, display "None".
 - * Clear the Code after ejecting the DISC.
- DC Offset
 - When the DC Offset detection information is shown as "None", it means that the offset is not detected. When it is shown as "Detect (x)", it means that the offset is detected.
 - X=0~3 : The number of capacitor leak detected.
 - Clear the detection information using the [Clear] key.
- Service Information
 - Display Power On time and the number of Monitor Open.
 - Pressing the [Init] key for 1 or more second initializes the service information being displayed.

TEST MODE

3.4 Serial No. Entry screen

Enter the serial code of each set from this screen.
 The Serial No. Entry screen is shown in Figure 3.4.

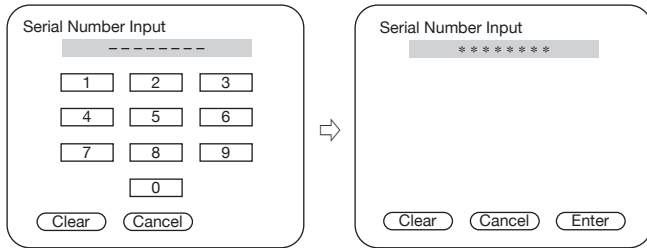

Figure 3.4 Serial No. Entry screen

Key Specification

- 0~9 : 10key used to enter the serial No.
- Clear : Clear the serial No. being input.
- Cancel: Transfer to Service screen
- Enter : Start entering the serial No.
 (When the entry is successfully completed, the “Write OK” is shown. When the entry is not successfully completed, the “Write NG” is shown)
 When the “Write OK” is shown, use this key to transfer to the Service screen.
 If the “Write NG” is shown, transfer to the Test mode again and repeat the entry from the first step.

3.5 DVD Service Information screen

This screen is to show DVS-8000 service information. This screen is also used to transfer to DVS-8000 Adjustment screen.
 The DVD Service screen is shown in Figure 3.5.

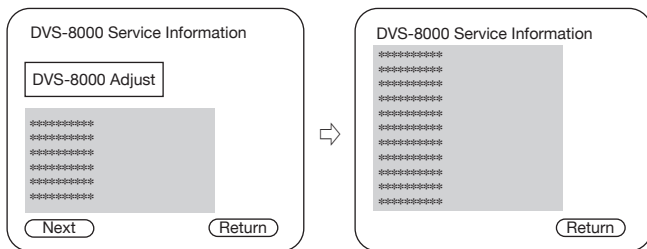

Figure 3.5 DVD Service Information screen

Key Specification

- DVS-8000 Adjust: Transfer to DVS-8000 Adjustment screen
- Next : Transfer to next DVS-8000 Service Information screen.
- Return : Transfer to Test Mode Main screen

3.5.1 DVS-8000 Adjustment screen

This is to display DVS-8000 Servo Adjustment screen.
 Refer to the Mechanism Specification for the detail setup.

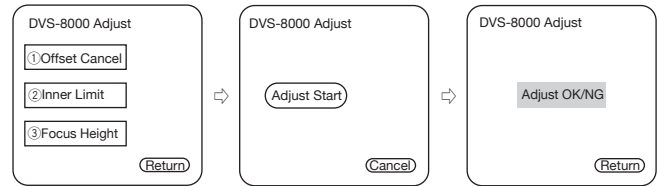

Figure 3.5.1 DVS-8000 Adjustment screen

Key Specification

- Offset Cancel : Adjust the offset cancel.
- Inner Limit : Adjustment of inner circumference limit
- Focus Height : Adjustment of focus height
- Adjust Start : Start of adjustment
- Return (the First screen) : Transfer to Test Mode Main screen.
- Cancel/Return : Transfer to DVS-8000 Adjust screen (Initial screen).

3.6 Tuner Mute Level screen

Adjust the Mute Level stored in the E2PROM of the Tuner F/E.
 The Tuner Mute Level Setup screen is shown in Figure 3.6.

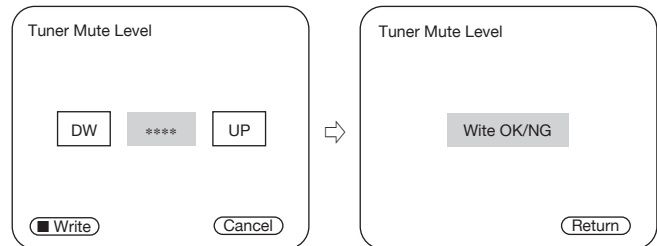

Figure 3.6 Tuner Mute Level Setting screen

Key Specification

- UP : Mute Level Up
- DW : Mute Level Down
- Write : Press and hold (for 1 seconds or longer) to make the entry in the E2PROM.
- Return : Transfer to Service screen.

* Adjust the Tuner Mute Level under the following conditions. Under the other conditions than the followings, the Tuner Mute Level cannot be adjusted if the Tuner Mute Level Setup screen is shown.

The frequency shall have to be set before transferring to the Setup screen.

- Audio Source : Tuner
- LOUD : OFF
- Volume : Step30

TEST MODE

Frequency : Default value of the set

Note that the frequency remains unchanged after exiting from the Setup screen at the completion of the setup.

3.7 Direct Select screen

Transfer to the Direct Select screen. Source Direct screen shall have the screen that has 9 keys. Audio Control/Setup shall be done in the same manner as in the normal screen transfer.

3.8 Touch screen

Fine-tune the variations of touch feeling in of each set.

Touch 4 markers one by one, and the adjustment is completed when the "Write OK" is shown on the screen.

If the "Write NG" is shown, transfer to the Test mode again to re-start the adjustment from the first step.

The Touch Adjustment screen is shown in Figure 3.8.

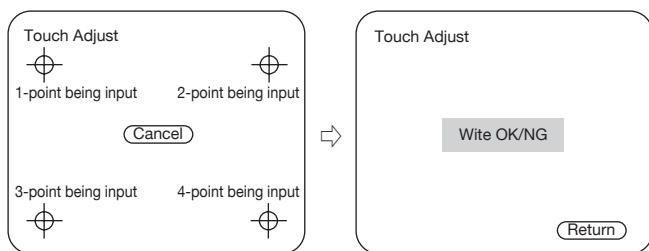

Figure 3.8 TOUCH screen

Key Specification

Cancel: When the Cancel button is pressed while entering the 1st point, the system transfers to the Test Mode Main screen.

When the Cancel button is pressed while entering the other point than the 2nd point, the system transfers to the status to enter the 1st point.

Return : Transfer to Test Mode Main screen

3.9 HPOSI screen

Adjust horizontal position of each screen.

The screen shall be transferred like; "Graphic→NAVI".

Graphic and NAVI of DNX are used in the adjustment of Dot FREQ/Phase. The Adjustment screen is shown in Figure 3.9.

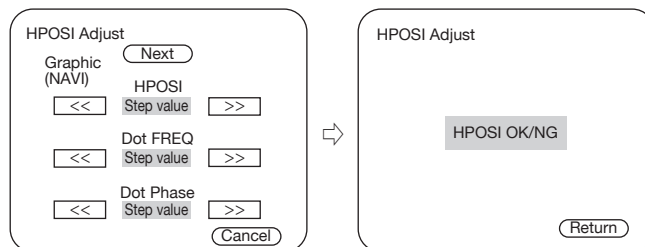

Figure 3.9 HPOSI screen

Key Specification

Next : Transfer to the next HPOSI Adjustment screen.

When the screen is NAVI, the screen starts writing in the E2PROM.

<< : Screen toward the left.

>> : Screen toward the right.

Cancel: Transfer to Test Mode Main screen

Return : Transfer to Test Mode Main screen

If HPOSI NG (E2PROM Write NG) is shown, transfer to the Test Mode again to start over the adjustment.

3.10 iPod screen

Check communication for iPod authentication.

The iPod screen is shown in Figure 3.10.

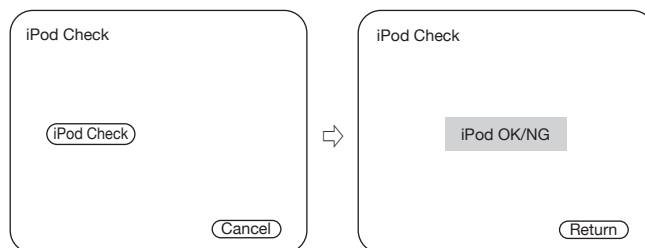

Figure 3.10 iPod screen

Key Specification

iPod Check : Start checking communication for iPod authentication.

Cancel, Return: Transfer to Test Mode Main screen

TEST MODE

3.11 Auto Adjust screen

Carry out the automatic adjustment of Chroma / Mstar.
 The contents displayed on the Auto Adjust screen are shown in Figure 3.11.

Note: Refer to the hardware service documents for the equipment to connect to the set.

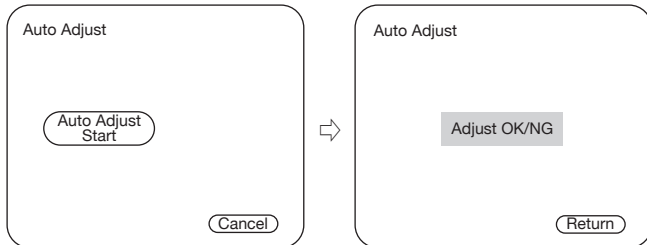

Figure 3.11 Auto Adjust screen

Key Specification

Auto Adjust Start : Start automatic adjustment.
 Cancel, Return : Transfer to Test Mode Main screen

3.12 Inverter screen

Change the inverter frequency.
 The Inverter screen is shown in Figure 3.12.

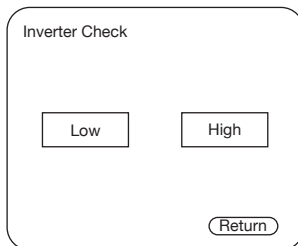

Figure 3.12 Inverter screen

Key Specification

Low : Set the inverter frequency at Low level.
 High : Set the inverter frequency at High level.
 Return : Transfer to Test Mode Main screen

3.13 NAVI screen

Check the system in preparation for updating the Navigation MAP data.

The NAVI screen is shown in Figure 3.13.

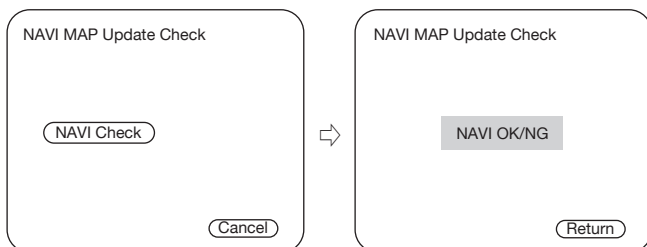

Figure 3.13 NAVI screen

Key Specification

NAVI Check : Access Navigation to update NAVI MAP.
 Cancel : Transfer to Test Mode Main screen
 Return : Re-start the system in the normal mode.

- * Note that the screen will be blanked for a moment after the NAVI Check is executed.
- * Regardless of the result (OK or NG) of the check, the system clears the Test mode after this check and it is re-started in the normal mode

4 Functional specification

This section describes the test mode specification in each function.

4.1 Display

In the Test mode, the display is exclusively used for the test but screens for Source Control, Audio Control and Setup are same as those that are normally used.

The system shows the touch position (+). However, it is not shown in the Touch Adjust screen (under adjustment).

4.2 Key

The hard key specification is listed in Table 4.2. (Note that the keys that are not listed in the table have conventional functions.)

Table 4.2 Hard key

Key	KVT	DDX/DNX
Auto	Motor driver	-
Press and hold [NAV] key	DVD audio and video switching	DVD audio and video switching

(Reference)

Mode Description	KVT	DDX/DNX
Test Mode	OPEN+SRC+Reset	SRC+ATT+Reset
Span switching	SRC+VOL.DW+Reset	NAV+EJECT+Reset
DC Offset/Service/Memory Other Clear	EJECT+AUTO+Reset	SRC+FUNC+Reset
Retailer mode: ON	EJECT+VOL.DW+Reset	EJECT+FUNC+Reset
Retailer mode: OFF	SRC+Reset	SRC+Reset
RDS test drive mode	EJECT+ATT+Reset	EJECT+ATT+Reset

4.3 Remote controller

The remote controller key specification is listed in Table 4.3. (Note that the keys that are not listed in the table have con-

TEST MODE

ventional functions.)

The mode of the remote controller shall be "AUDIO".

Table 4.3 Remote Controller key

Key	Function
Band (FM+)	DVD video inspection switching
M/S (AM-)	DVD audio inspection switching
Tenkey0	Flicker Adjustment
Tenkey1	Illumination switching (Switch from Red to Green or vice versa (Red↔Green) only at KVT) * Other than [variable] key
Tenkey2	Check DC Offset
Tenkey3	Change the V-IN (R-CAM) mirror mode switching
Tenkey5	NAVI forced interruption (Audio)
Tenkey6	Call Screen Adjustment screen
Tenkey7	Direct call of variable illumination green
Tenkey8	Direct call of variable illumination blue
Tenkey9	Direct call of variable illumination red

4.4 Video Control

- In conjunction with change of the audio source, change AV-OUT (In the case of Graphic and NAVI, use AV-IN instead of AV-OUT).
 AVIN → AV-OUT: AVIN
 iPod → AV-OUT: iPod
 DVD → AV-OUT: DVD
 USB → AV-OUT: USB
 TV → AV-OUT: TV

4.5 Tuner

- When unable to access E2PROM, display Error (on the Tuner screen).
- K3I forced switching
 Forced to Narrow by pressing and hold Preset 4: xxx.x1MHz
 Forced to Middle by pressing and holding Preset 5: xxx.x2MHz
 Forced to Wide by pressing and holding Preset 6: xxx.x3MHz
- KVT: [SRC] key+[VOL.DW] key+[Reset] key
 DDX/DNX: [NAV] key+[EJECT] key+[Reset] key
 Use the above keys to change between Span (K↔M).
 Span information is displayed on the Information screen.
- When RDS PS is "RDS_TEST" in the Tuner source, turn OFF P-CON.

4.6 TV Tuner

- In the case of destination E, the default value of TV1 shall

be "Area 5 (Russia), 8ch (191.25MHz)" (when KTC-V500 is connected).

- In the case of destination E, the default value of TV1 shall be "Area 4 (Russia), 8ch (191.25MHz)" (when KTC-V300 is connected).
- * If started up as above, even if the Test mode is cleared by ACC, Power OFF → ON, the setting values are maintained. (The default value is resumed by the Reset.)

4.7 DVD

- Use CD media KTD-02A, DVD media TDV-540A/TTD-100 to play back in the order of the following sequence.
- Use "Title1-Chapter1" while Loading.
- Check CDDA (KTD-02A)
- Use "Track UP/DW" to play back in the order of sequence as shown below:
 1 ↔ 9 ↔ 15 ↔ 10 ↔ 11 ↔ 12 ↔ 13 ↔ 14 ↔ 9 ↔ 1...
 Track 28 is directly selected by pressing [RDM] key.
- DVD audio/video checking (TDV-540A)
 Use "Chapter UP/DW" to play back in the order of sequence as shown in Tables 4.7 and 4.8.
 Use FM/AM on the remote controller to change the video/audio check.

Table 4.7 DVD Video check

For DVD video checking.				
Title	Chapter			
3	6	Level		Audiostream1
3	17	AM/PM noise		Audiostream1
3	8	Frequency characteristics		Audiostream1
3	12	Color measurement		Audiostream1
4	1	1kHz 0dB	PCM96k/24bit	Audiostream3
4	6	17Hz	PCM96k/24bit	Audiostream3

Table 4.8 DVD Audio check

For DVD audio checking.				
Title	Chapter			
4	1	1kHz 0dB	PCM96k/24bit	Audiostream3
4	6	17Hz	PCM96k/24bit	Audiostream3
4	16	44kHz	PCM96k/24bit	Audiostream3
4	2	Infinity	PCM96k/24bit	Audiostream3
4	3	L	PCM96k/24bit	Audiostream3
4	4	R	PCM96k/24bit	Audiostream3
4	1	1kHz 0dB	Dolby	Audiostream1
4	2	Infinity	Dolby	Audiostream1

TEST MODE

4.8 Audio

- The default setting of Volume shall be Step 30.
- In setting up BAL/FAD, the setting “MIN ↔ CENT ↔ MAX” can be made by 1 click.
- In setting up Xover, the setting “MIN ↔ MAX” can be made by 1 click.
- In setting up Tone, the setting “MIN ↔ CENT ↔ MAX” can be made by 1 click.
- The default setting of Tone (EQ) shall be Flat.
- The default setting of System Q shall be Off.
- When there is Digital Out terminal, the setting shall be such that the output is always On.
- The default setting of Line Mute shall be On.

4.9 AVIF

- The default setting of AVIN Interruption shall be On.
- The default setting of R-CAM Interruption shall be On.
- Normally an interruption occurs when the R-CAM is detected.
- Reverse condition shall be always On.
- The default setting of SP for NAVI interruption shall be Front ALL.
- Use Tenkey 3 on the remote controller to change V-IN mirror mode.

4.10 Screen adjustment

- By pressing Tenkey 5 on the remote control on each video screen, each video screen's Screen adjustment items are displayed.
- The default value is Center. 1 Items can move between “Full Down ↔ Center ↔ Full Up” by 1 click.
- The default setting of DIMMER Mode shall be SYNC.

4.11 DC Offset

- DC Offset detection status (normal/error) clear
Clear DC Offset detection information of E2PROM with DC Offset detection information [Clear] key on the Service Information screen.
- DC Offset detection information is displayed on the Information screen/Service Information screen.
- In the Test mode, even if DC Offset is detected, it is not written into E2PROM.
However, the detection operation shall be carried out and when the DC Offset is detected, the Protect shall be displayed and it becomes all CH Mute operation.
- Volume setting can be changed to the following settings by pressing Tenkey 2 on the remote controller.
Source : DVD

Assigned DISC : KTD-02A

Assigned Track : 15 (20Hz, 0dB)

Assigned VOL : 26 Step (Low)

4.12 Flicker adjustment

- ① Use Tenkey 0 on the remote controller to turn the Flicker adjustment On.
 - ② Slide the monitor at the foreground, and make the screen mode FULL, and set the video to “KVT: VIDEO, DDX/DNX: R-CAM”.
 - ③ Press Tenkey 0 on the remote controller during the flicker adjustment to turn the adjustment Off.
 - ④ Slide the monitor innermost (Test mode default value), make the screen mode FULL, and make the video as it is changed and used during the adjustment.
- * The OSD can be shown normally during the flicker adjustment.
 - * When changing R-CAM of DDX/DNX, the detection at the Reverse terminal is neglected and the system is switched to R-CAM.

4.13 Driver for Panel Mechanism Motor (Only in KVT Series)

- With the condition when [AUTO] key is pressed and hold, the driver port for motor shall be turned On.
- While [AUTO] key is being pressed, the motor is turned On in reverse direction when the key is On for the first time and the motor is stopped when the key is Off.
- With the key is pressed On for the second time, the motor is tuned On in the normal (forward) direction, and the motor is stopped when the key is Off. Repeat the same steps in the succeeding procedure.

4.14 Clearing E2PROM contents

- Clear the E2PROM contents which should not remain in it when shipping the unit.
KVT: [EJECT] key + [AUTO] key
DDX/DNX: [SRC] key + [FNC] key
Clear the contents of E2PROM using the [above] key + [Reset] key.
Clear OK : Key illumination blinks (twice)
Clear NG : Nothing happens.
The following information is cleared:
DC Offset information / Memory information / Retailer mode information / Service information
- If a jig is connected and the region is written in, the following information shall be cleared.
- * When region code has been written in E2PROM, contents

TEST MODE

of the E2PROM are not cleared if the same region code is written.

Only when the different region code is written, contents of the E2PROM are not cleared.

Serial No. / Security code / Touch correction / HPOSI correction / Chroma adjustment

DC Offset information / Memory function / Retailer mode information / Service information

- * **Note:** Since the above data is cleared (un-defined) when the E2PROM has been replaced during the service, it is required to re-adjust the data in the Test mode.

4.15 Security Code writing-in

- When entering the Security Code that is defined as a pair of the serial number of the product (for other destinations than K/R), use [Security Set Up] key on the Setup screen to call the Security screen.
- Only when the Security Code of E2PROM of the product for other destinations than K/R is blank, [Set] key is shown and press that key.
- In the Security Code Writing screen, run the same operation as when registering Security Code in normal mode, and press the [Enter] key to start writing.

- * **Note:** The Security Code to be entered in the above step is the set-specific code linked to the serial No.

- Writing of the code is successfully completed when “Complete” is displayed, and if “NG” is displayed, the writing the code is unsuccessfully completed.

- * **Note:** If “NG” is displayed, transfer to the Test mode again and repeat the above process from the 1st step.

- When the Security Code is Blank, the system is turned OFF in 30 minutes.

- * **Note:** In order to turn Security Off in the product whose destination is K/R while the Security of that product is turned On, turn the Security off from the Setup screen, or use the following steps to turn the Security off on the Security Code Input screen shown when the system is turned on: Press Tenkey 5 on the remote controller twice → Tenkey 2 four times → Tenkey 7 three times.

4.16 Other

- Do not operate the Back Up Memory function during the Test mode.
- In the Test mode, the color of illumination shall be white.
- The key illumination is in white but GUI shall be the initial value, and if the color is changed by the Setup this change of color is shown together with [GUI/] key.

ADJUSTMENT

List of Adjustment and Check Items for DVS-802xV and 812xV

1. Adjustments after replacement of pickup

The mechanism shall be adjusted to reduce variations among parts, which are inherent to the machine.

No.	Item	Overview	Disc
1	Offset Cancel Adjust	Stray light offset in the optical module	-
2	Inner Limit Adjust	Support recording of minimum limit for DVD+R/RW (To decide the focus on position.)	-
3	Focus Height Adjust	To decide focus on drive such that the pickup lens shall not hit on the disc.	TCD-782 TCDR-704

2. Contents to be checked

No.	Item	Overview	Overview
1	Check CD playback	TCD-782 (TNo.1, 23) Dropout of sound	TCD-782 (Any CD-DA)
2	Check DVD playback	Any irregularities of images or dropout of sound	Any DVD-Video

3. Adjustment procedure

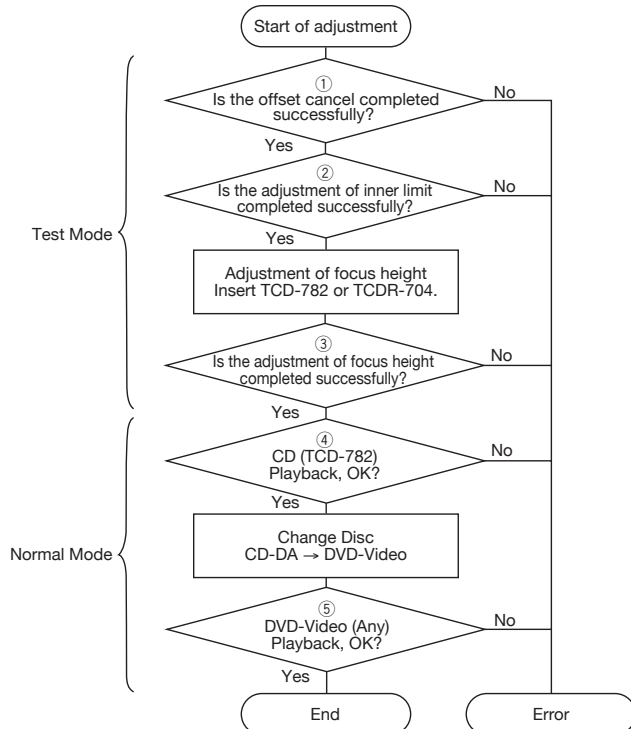

“Test Mode”

Adjustments ① through ③ shall be made in DVS-8000 Adjust of the Test mode.

[Service] → [DVS-8000] → [DVS-8000 Adjust]

① Offset Cancel

Condition: Run the cancel operation only when there is no disc in the unit.

Criteria: The “OK” shall be shown.

② Inner Limit SW Adjustment

Condition: Make the adjustment regardless of the disc is inserted in the unit or not.

Criteria: The “OK” shall be shown.

③ Adjustment of Focus Height

Condition: Make the adjustment when the disc (CD) is inserted in the unit

Criteria: The “OK” shall be shown.

“Normal Mode”

Run checks ④ and ⑤ in the Normal mode that is transferred by Power OFF → ON.

④ Check that CD can be played back.

Criteria: CD shall be played back normally.

⑤ Check that DVD can be played back.

Criteria: DVD shall be played back normally.

4. Contents of Failure

No.	Contents of Failure	Major cause
1	Failure in adjustment of focus height	<ul style="list-style-type: none"> • CD and/or LD does not turn on (Short in soldering) • Connector (Pick, Spindle) • Failure in spindle
2	Failure in inner limit adjustment	<ul style="list-style-type: none"> • Connector (Spindle) • Abnormal sled • Inner limit SW does not turn on.
3	Operation Check	<ul style="list-style-type: none"> • Disc scratch, Dirt, Pick

ADJUSTMENT

1. Flicker adjustment

● Condition

Video source: Video
 Video: Luster white 30%~50%
 BRIGHT: MAX
 MODE: FULL

● Adjustment procedure

- ① Display luster white 30%~50%.
- ② Place a flicker adjustment jig to the monitor and observe the waveform with an oscilloscope.
- ③ Turn X35-489: VR200 and adjust to make the amplitude of the waveform to minimum.

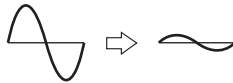

Oscilloscope range: 20mV, 0.5mS

● Note

- ① In checking the screen after the adjustment, move the monitor up and down in order to confirm that the screen does not flicker. (This check is also carried out on the 07 model.)
- ② Noise due to AC200V can be observed in the flicker adjustment jig and oscilloscope and thus carefully set up the power supply and GND of the jig and oscilloscope.
 * In 07 model, GND of the measurement equipment has been floated.

2. VCOM Amplitude and AGC and WB Automatic adjustments

● Adjustment conditions

Input signal: Input white 100% (NTSC) in R-CAM.

● Adjustment Method

- ① Press Auto Adjust on the Test Mode Main screen.



- ② After the automatic adjustment, "Auto Set OK" will be shown to indicate the completion of the adjustment.

3. Adjustment of Horizontal display start position and pixel

● Video displayed on Adjustment screen

GRAPHIC : Special screen used only for adjustment (See below)

DNX_NAVI : Special screen used only for adjustment of GARMIN (See below)

DDX_NAVI : Input KNA-G520.

● GRAPHIC

Pixel Adjustment key (DOT_PHASE): Adjustment of horizontal display position of pixel (Default: 32)

Screen Position Adjustment key (HPOSI): Adjustment of horizontal display starting position of the entire screen (Default: 0)

Display Range Adjustment key (DOT_FREQ): Adjustment of horizontal display range of the video (Default: 64)

ADJUSTMENT

• GRAPHIC Adjustment screen

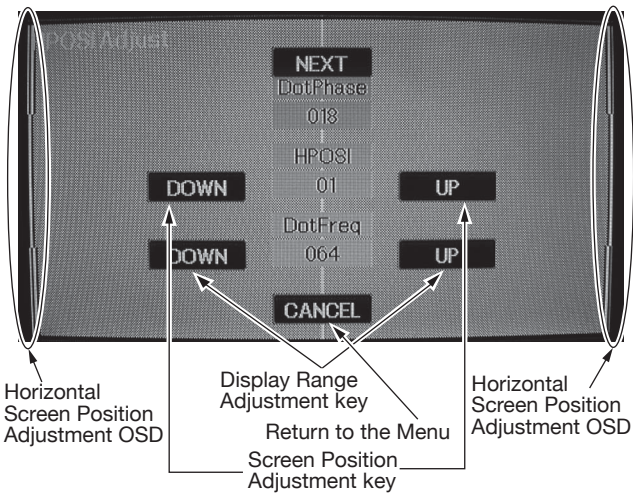
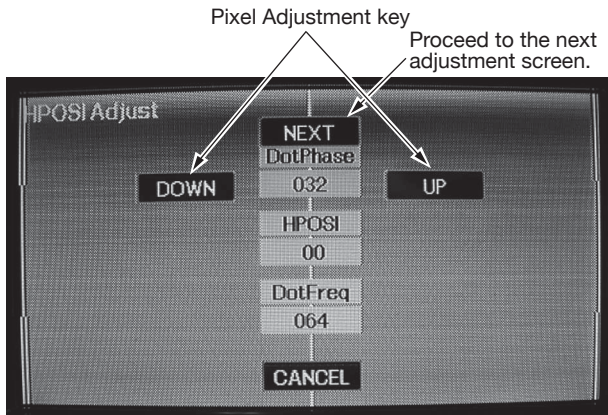

● NAVI

Pixel Adjustment key (DOT_PHASE): Adjustment of horizontal display position of pixel (Default: 32)

Screen Position Adjustment key (HPOSI): Adjustment of horizontal display starting position of the entire screen (Default: 0)

Display Range Adjustment key (DOT_FREQ): Adjustment of horizontal display range of the video (Default: 64)

• NAVI Adjustment screen

DDX

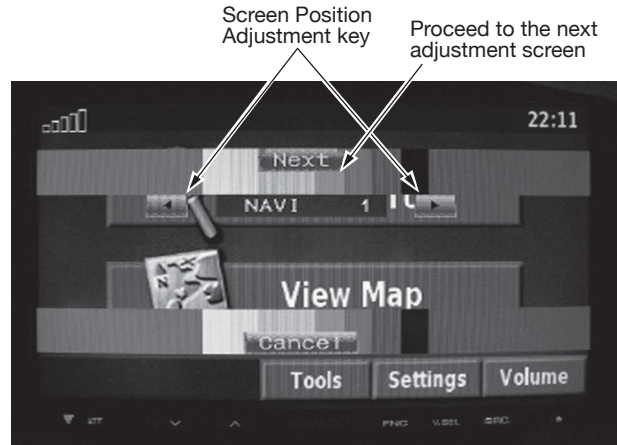

DNX

Procedure to display NAVI Adjustment screen

- ① Start the set.
- ② Connect special jig on MINI_USB of NAVI.

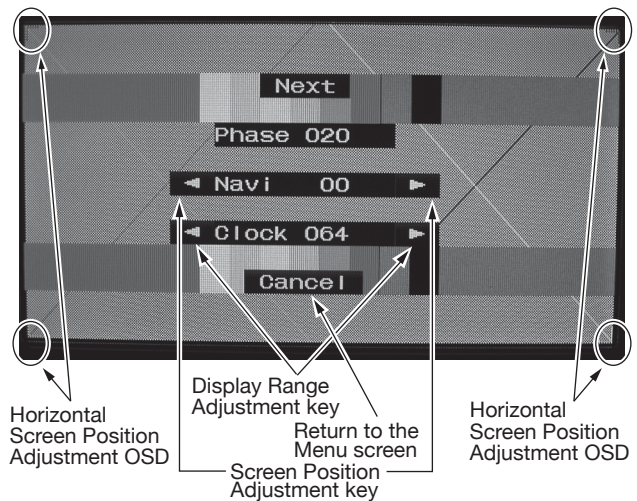
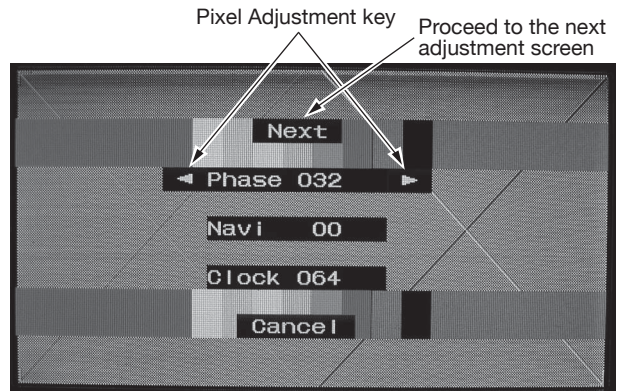

ADJUSTMENT

● Adjustment Procedure

① Press HPOSI on the Test Mode Main screen.

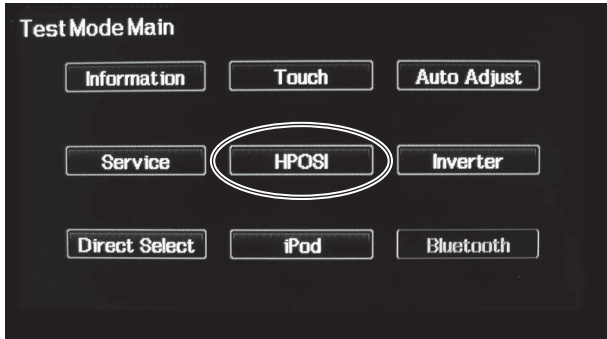

• Screen Position Adjustment: GRAPHIC

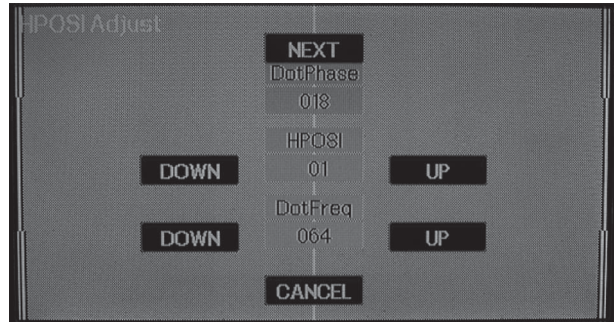

②-1 Graphic

Then, adjust the Pixel Adjustment key so that the screen becomes gray.

After the completion of the adjustment, press "NEXT".

• Pixel Adjustment: GRAPHIC

OK



NG

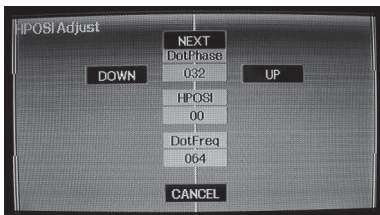

②-3 Graphic

Then, adjust the Display Range Adjustment key so that there is no vertical black stripes (blur) on the screen.

After the completion of the adjustment, press "NEXT".

• Adjustment of display range: GRAPHIC

OK

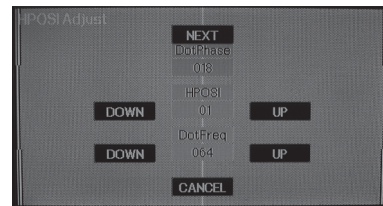

NG

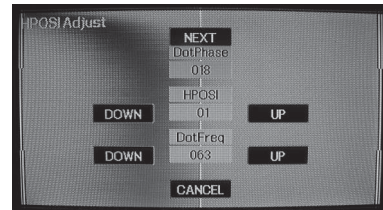

Enlarge OK



Enlarge NG



③-1-1 DNX_NAVI

Adjust the Pixel Adjustment key so that the screen becomes gray.

After the completion of the adjustment, press "NEXT".

• Pixel Adjustment: DNX_NAVI

OK

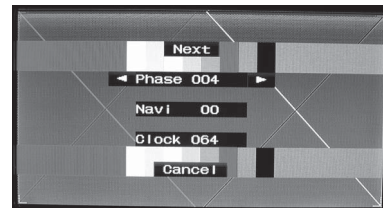

NG

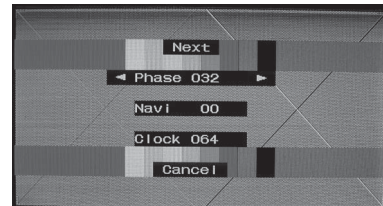

②-2 Graphic

Adjust the Screen Adjustment key so that the screen becomes horizontally symmetrical.

ADJUSTMENT

Enlarge OK



Enlarge NG



Left side
OK

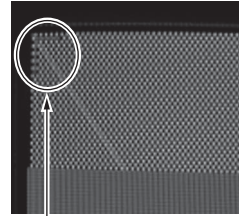

One white dot can be seen on the left side

NG

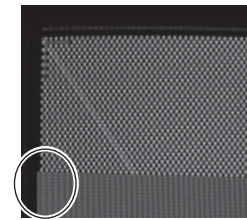

OSD is shown out side of the screen

NG

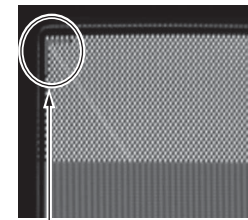

Move an arrow symbol to left side

③-1-2 DNX_NAVI

Adjust the Screen Adjustment key so that the screen becomes horizontally symmetrical.

- Screen Position Adjustment: DNX_NAVI

Right side
OK

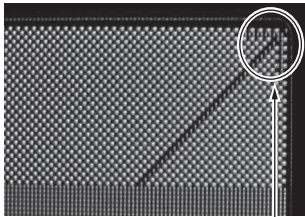

One white dot can be seen on the right side

NG

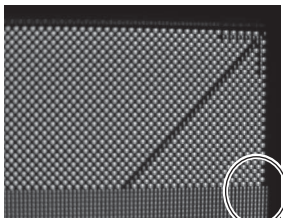

OSD is shown out side of the screen

NG



Move an arrow symbol to right side

③-1-3 DNX_NAVI

Then, adjust the Display Range Adjustment key so that there is no vertical black stripes (blur) on the screen. After the completion of the adjustment, press "NEXT".

- Adjustment of display range: DNX_NAVI

OK

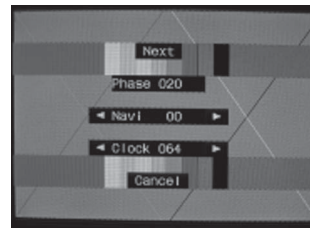

NG

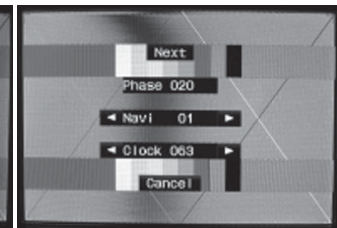

ADJUSTMENT

③-2-1DDX_NAVI: KNA-G520

Adjust the Screen Adjustment key so that the NAVI screen becomes horizontally symmetrical.

After the completion of the adjustment, press "NEXT".

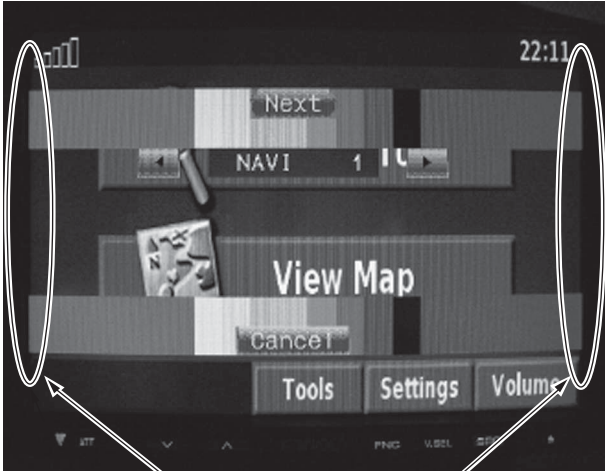

Adjust the space to become horizontal symmetry

Enlarge OK

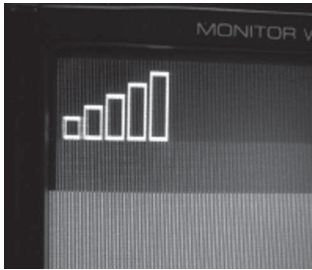

Enlarge OK

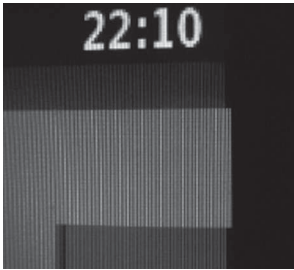

Confirmation after adjustment

After the adjustment, check that the screen is horizontally symmetrical and that there is no blur on the screen.

The "HPOSI OK" will be shown to indicate the completion of the adjustment.

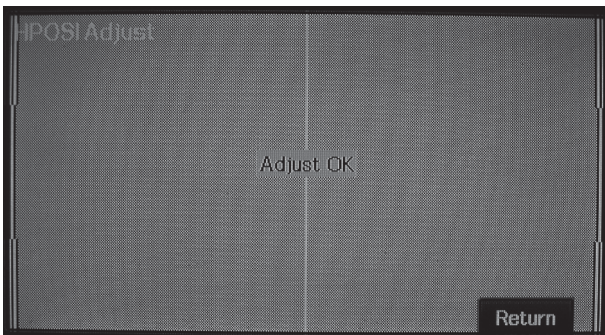

4. Touch panel adjustment

● Adjustment procedure

① Press the Touch Key on the Test Mode Menu screen to enter the Touch panel adjustment screen.

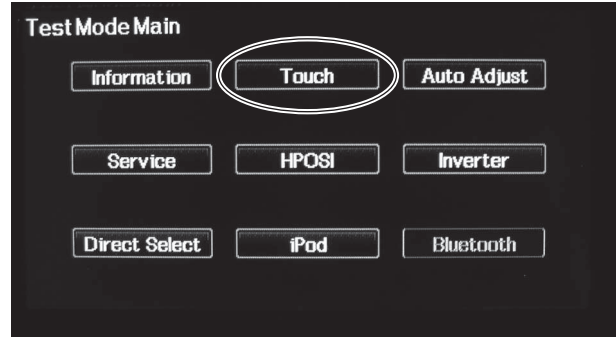

② Touch the center of "+" mark below in the following order. Upper left → Upper right → Lower left → Lower right
 To touch, make sure to use the designated touch stick.

③ After adjustment is completed for 4 areas, if "Write OK" is displayed, the adjustment is completed.
 Press Return to exit from the Touch screen.

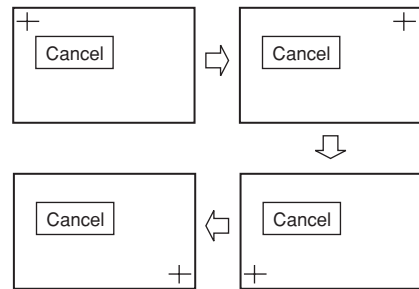

* If the center of "+" mark wasn't pressed accurately, press Cancel to start over the adjustment.

Note

The touch panel adjustment data is finalized when the touch stick is released from the mark.

Therefore, the Knack for Adjustment is not to release the touch stick from the mark right after touching the center of the "+" mark, but to confirm that the stick is exactly on the center of the "+" mark while keeping touching the screen. (If the stick is not exactly on the center of the mark, move the stick onto the center of the mark while keeping touching the screen.)

Then, quickly and vertically release the stick from the screen.

PC BOARD (COMPONENT SIDE VIEW)

VIDEO CONTROL UNIT
X15-108x-xx A/2
(J76-0481-12)

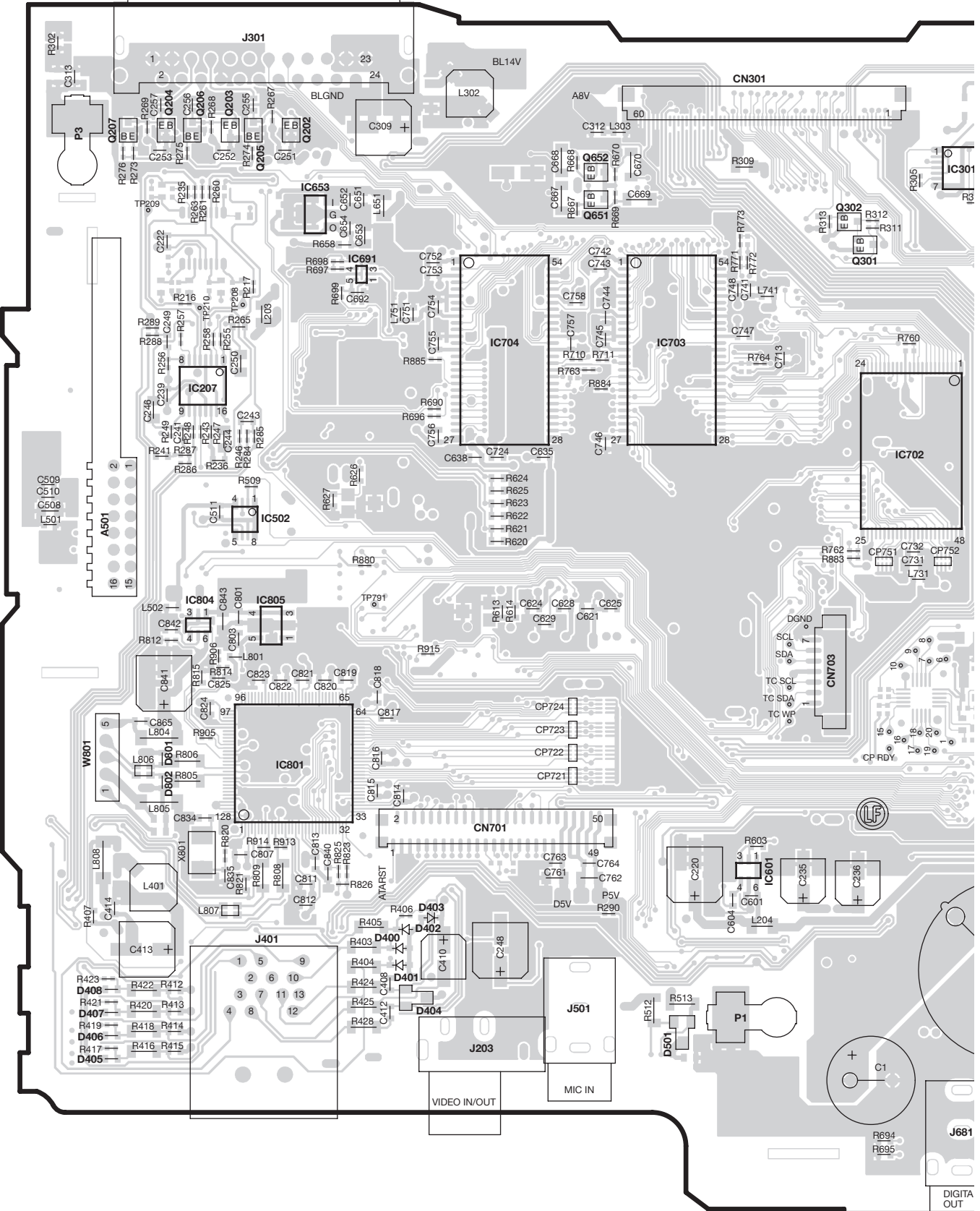

PC BOARD (FOIL SIDE VIEW)

VIDEO CONTROL UNIT X15-108x-xx A/2 (J76-0481-12)

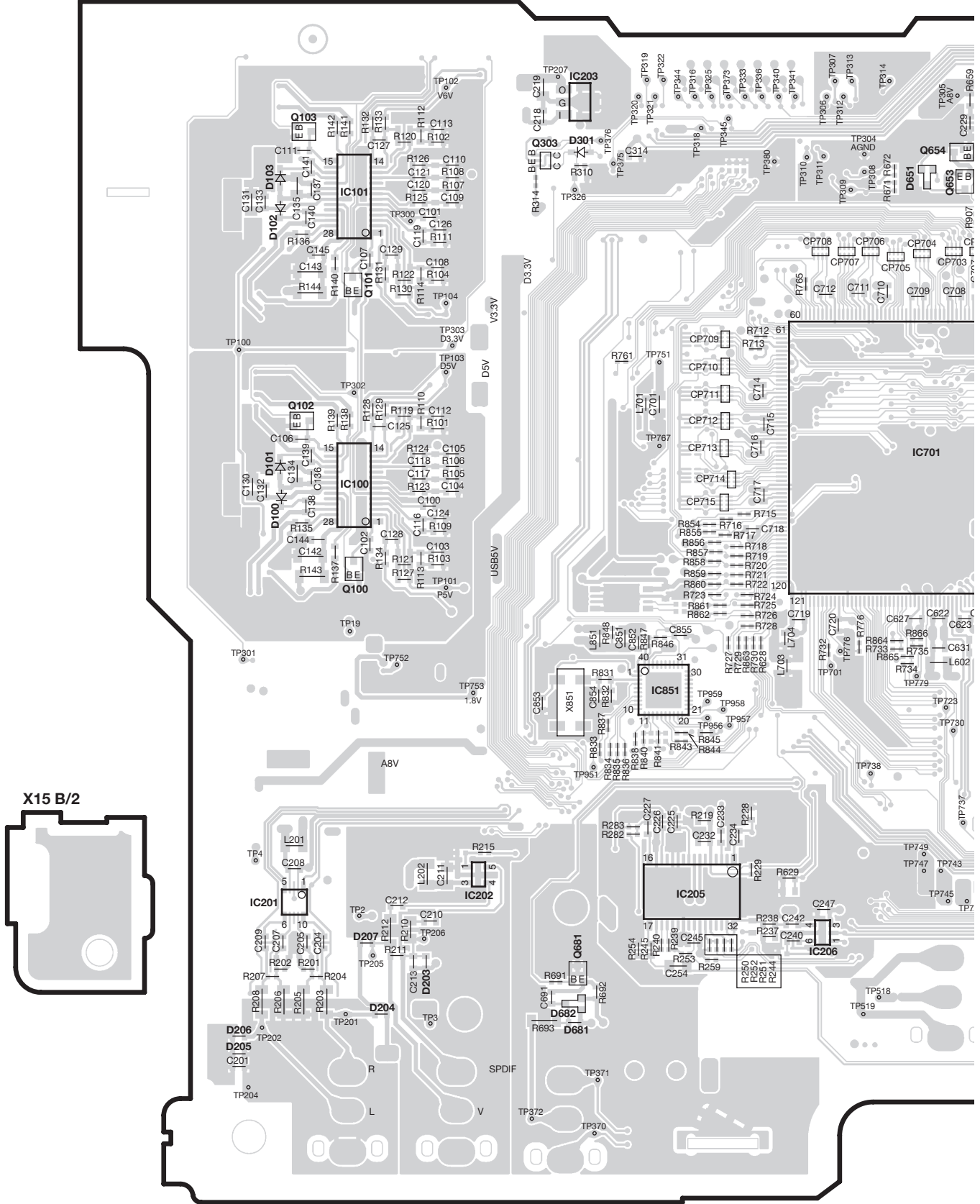

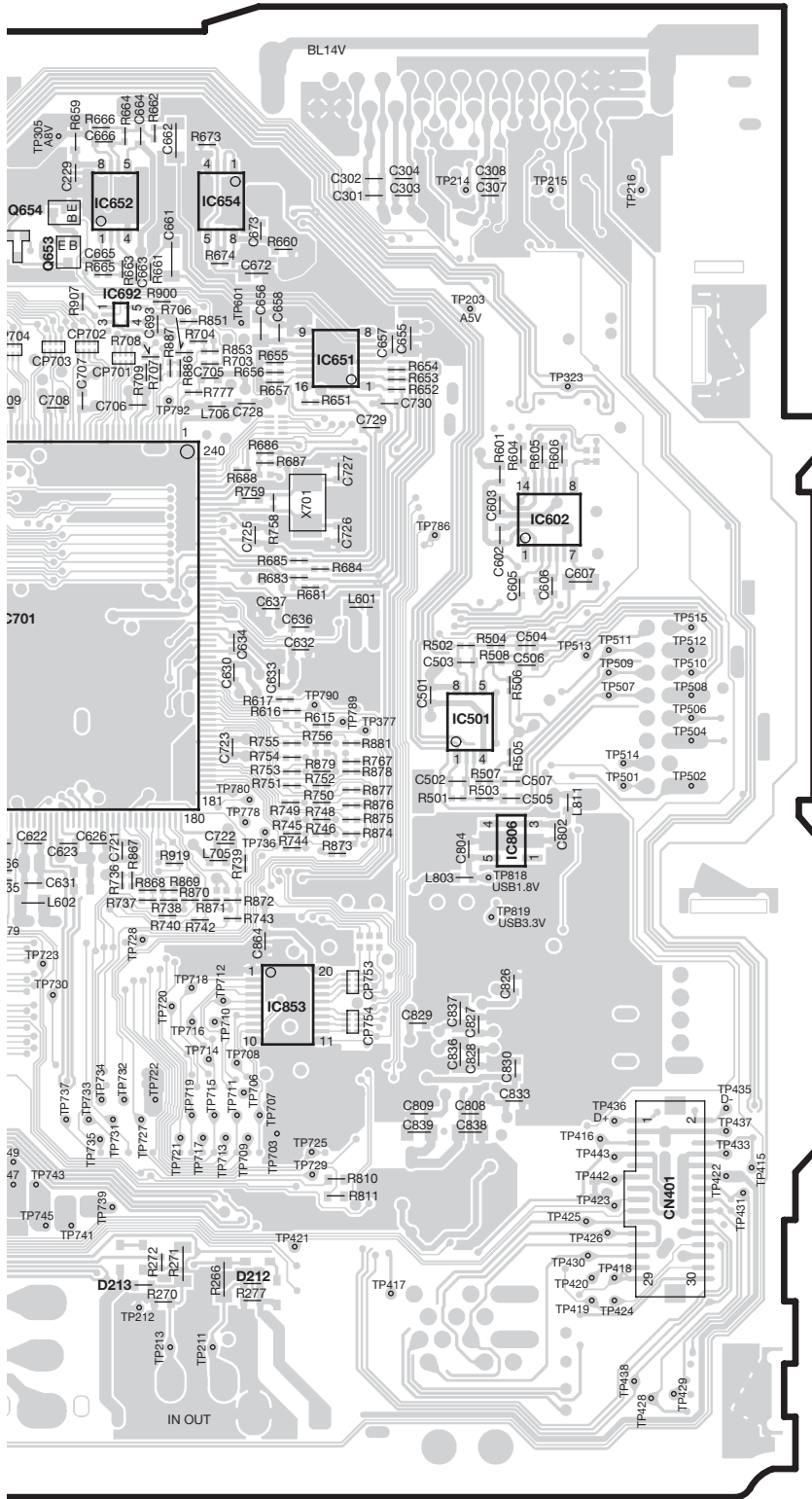

X15-108x-xx

Ref. No.	Address
IC100	4M
IC101	2M
IC201	6L
IC202	6M
IC203	2N
IC205	6N
IC206	6O
IC501	4Q
IC602	3Q
IC651	3Q
IC652	2P
IC654	2P
IC692	2P
IC701	4O
IC806	4Q
IC851	5N
IC853	5P
Q100	4M
Q101	3M
Q102	3L
Q103	2L
Q303	2M
Q653	2P
Q654	2O
Q681	6N

Refer to the schematic diagram for the values of resistors and capacitors.

PC BOARD (COMPONENT SIDE VIEW)

ELECTRIC UNIT
X34-575x-xx (J76-0480-12)

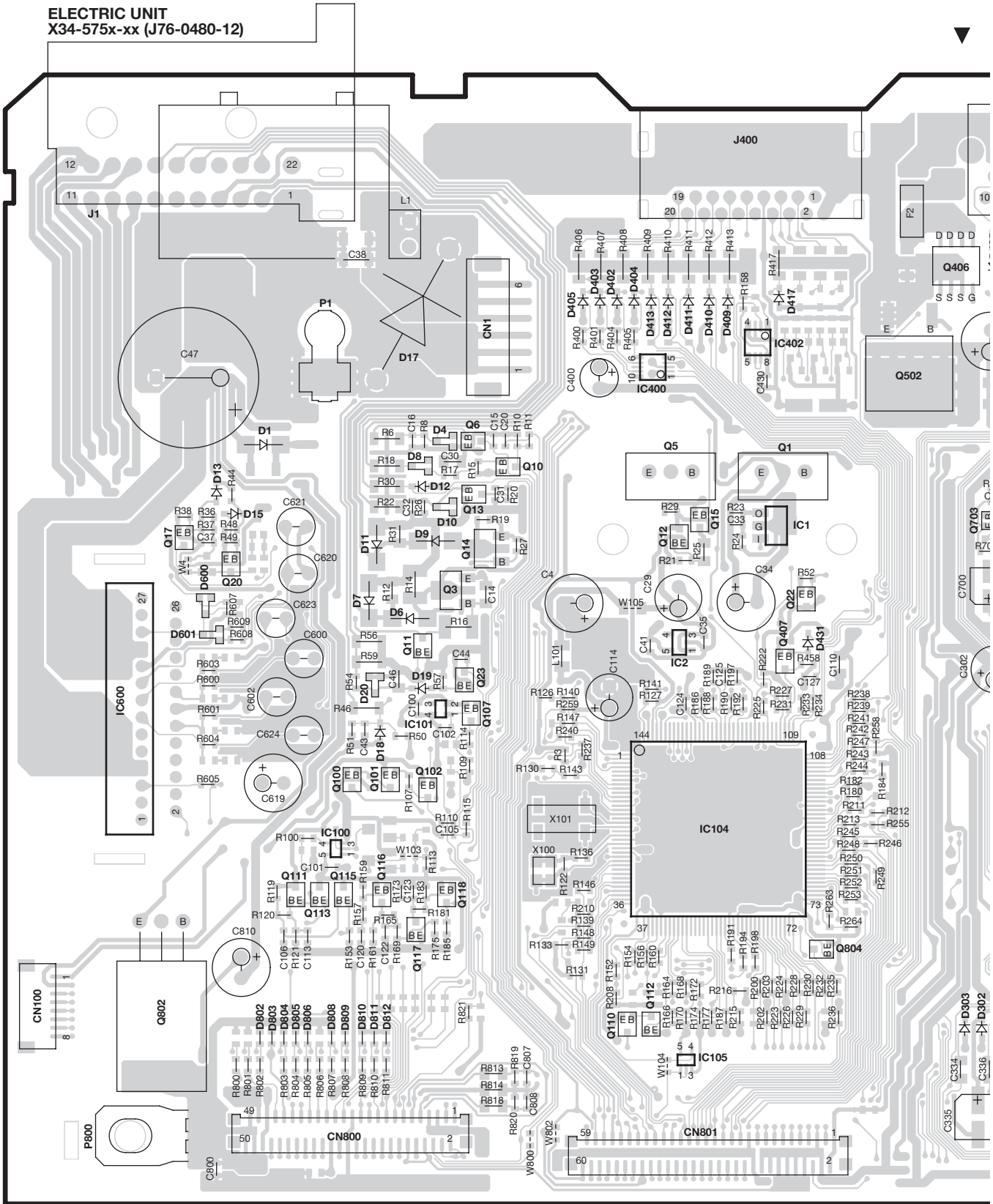

PC BOARD (FOIL SIDE VIEW)

VIDEO UNIT X35-4890-10 A/2 (J76-0482-12)

X35 B/2

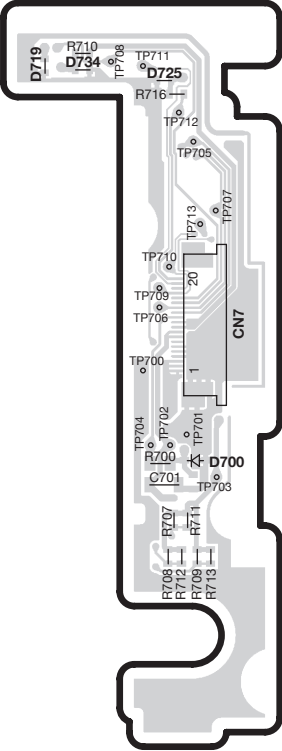

DAUGHTER UNIT X89-3062-70 (J76-0526-12)

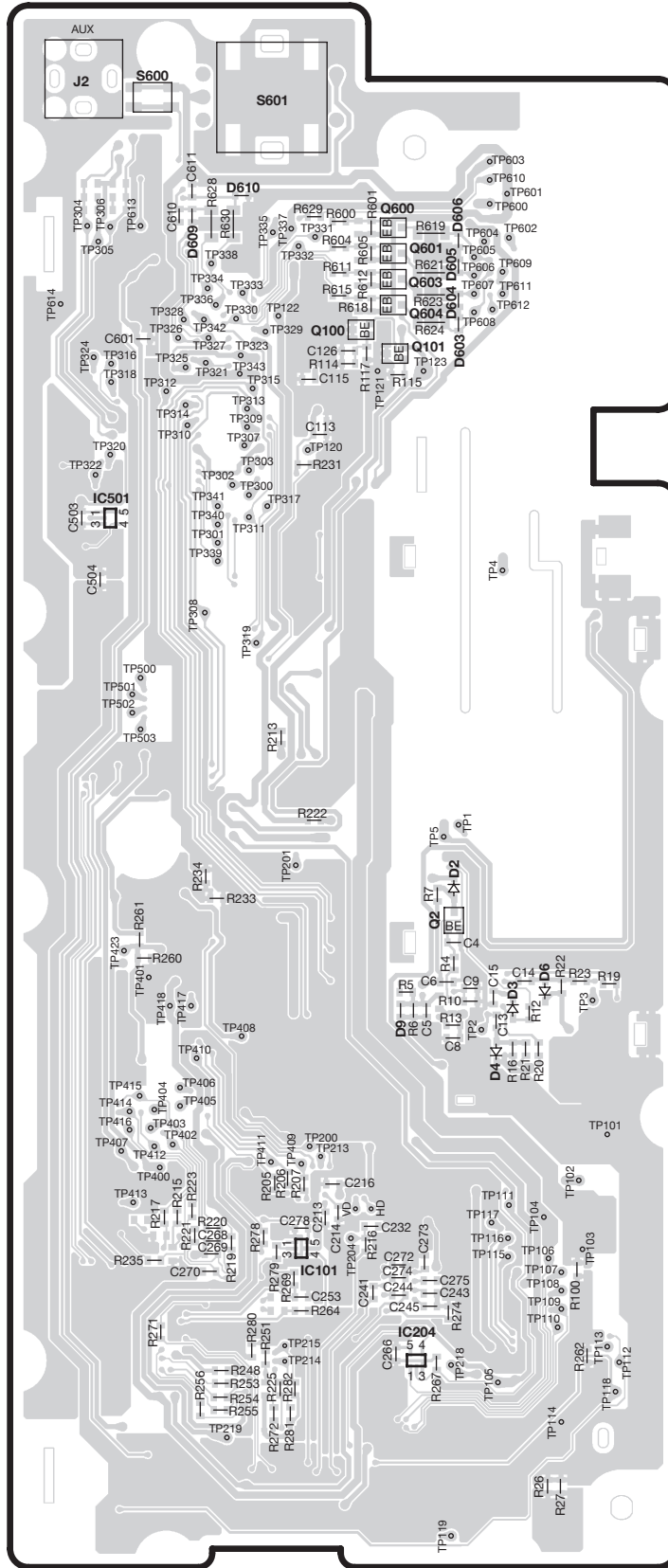
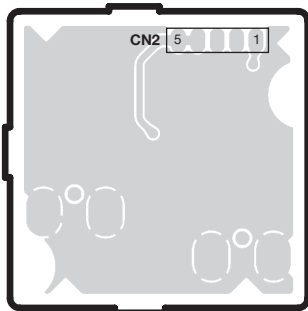

DDX5022/5022Y/5032/5032M/512/52RY
DNX5120/512EX/5220/5220BT

PC BOARD (COMPONENT SIDE VIEW)

DVD UNIT X37-1100-03 (J76-0160-22)

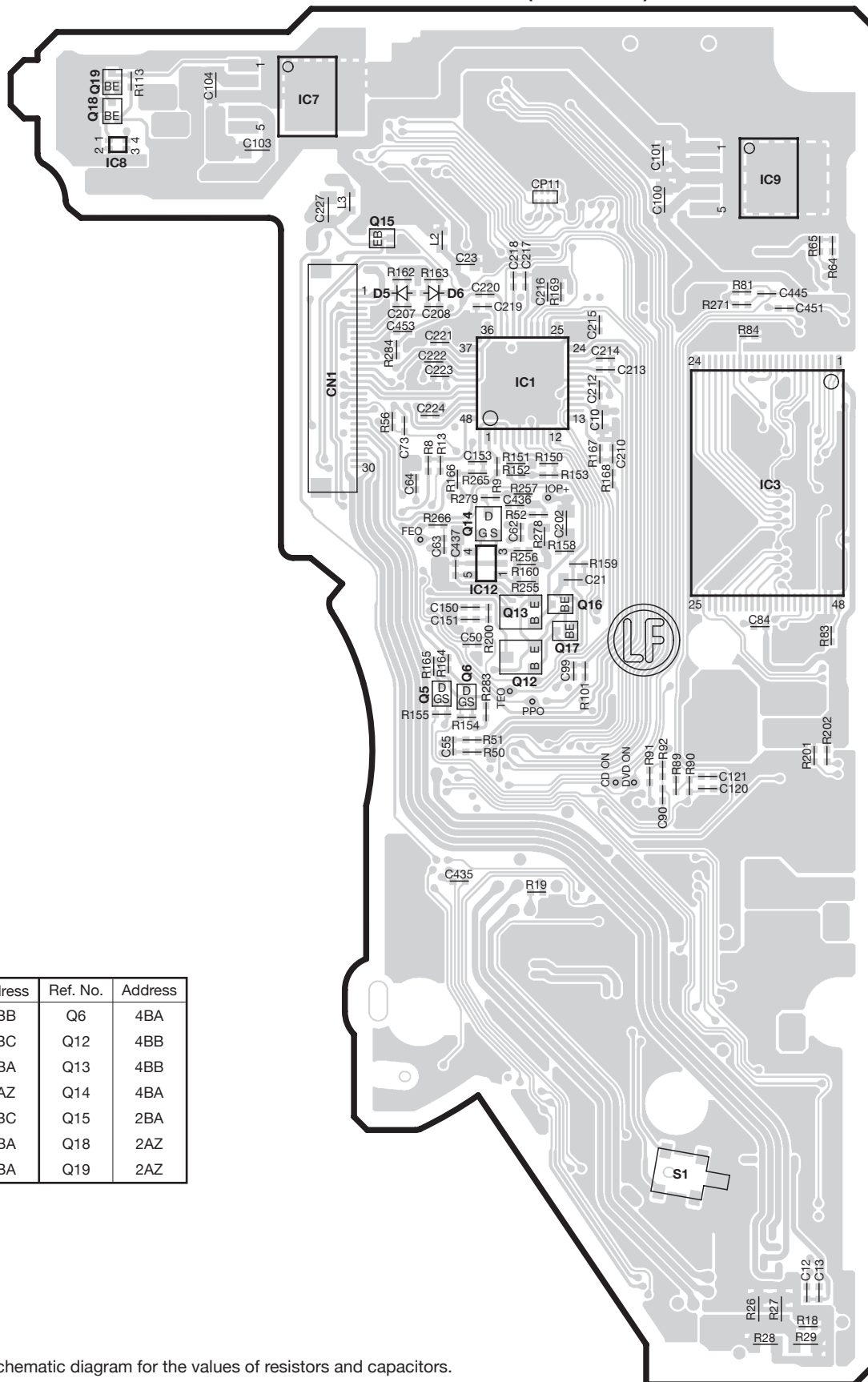

X37-1100-03

Ref. No.	Address	Ref. No.	Address
IC1	3BB	Q6	4BA
IC3	3BC	Q12	4BB
IC7	2BA	Q13	4BB
IC8	2AZ	Q14	4BA
IC9	2BC	Q15	2BA
IC12	4BA	Q18	2AZ
Q5	4BA	Q19	2AZ

Refer to the schematic diagram for the values of resistors and capacitors.

PC BOARD (FOIL SIDE VIEW)

DVD UNIT X37-1100-03 (J76-0160-22)

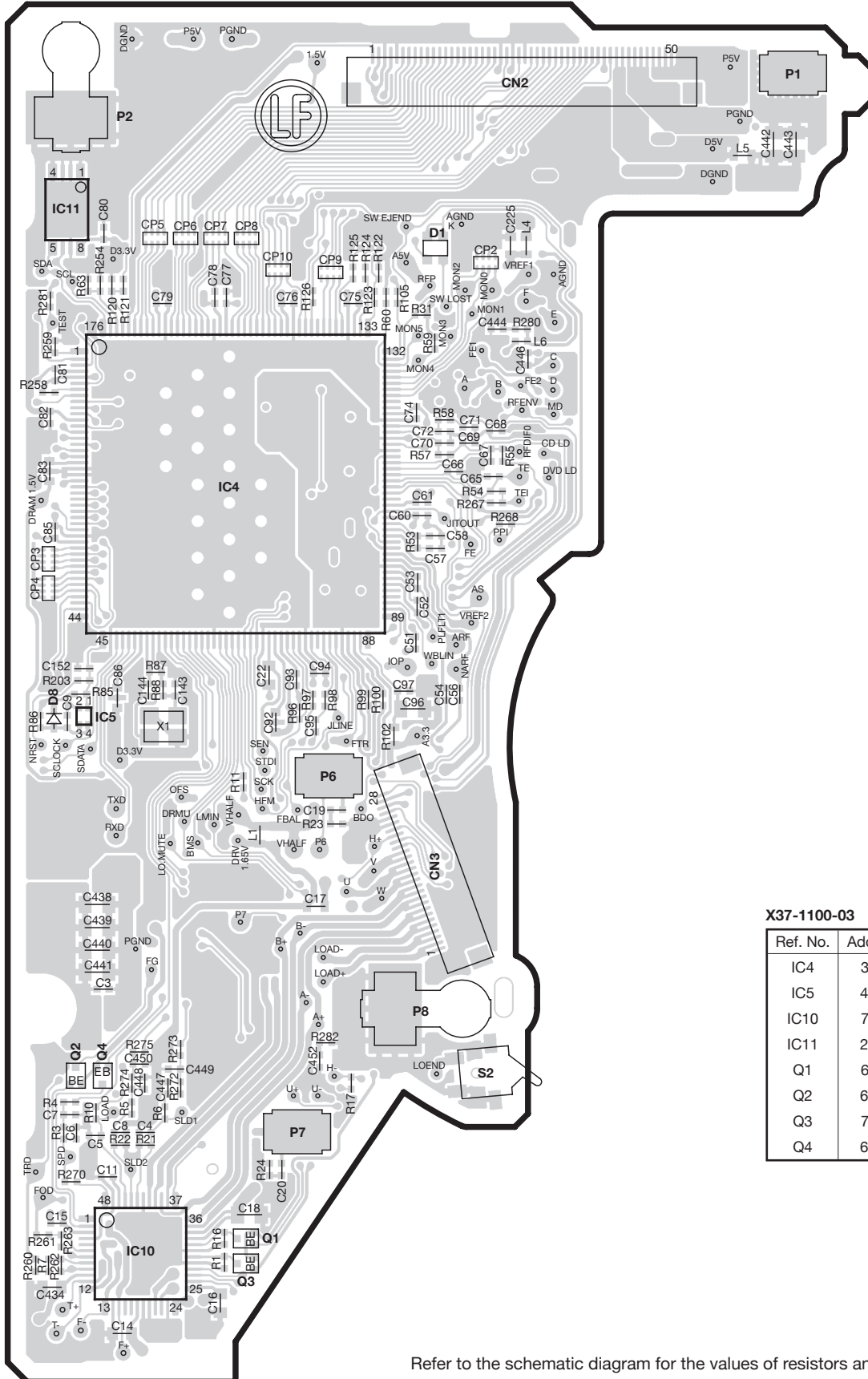

X37-1100-03

Ref. No.	Address
IC4	3BE
IC5	4BD
IC10	7BE
IC11	2BD
Q1	6BE
Q2	6BD
Q3	7BE
Q4	6BD

Refer to the schematic diagram for the values of resistors and capacitors.

(X15-108x-xx) (A/2)

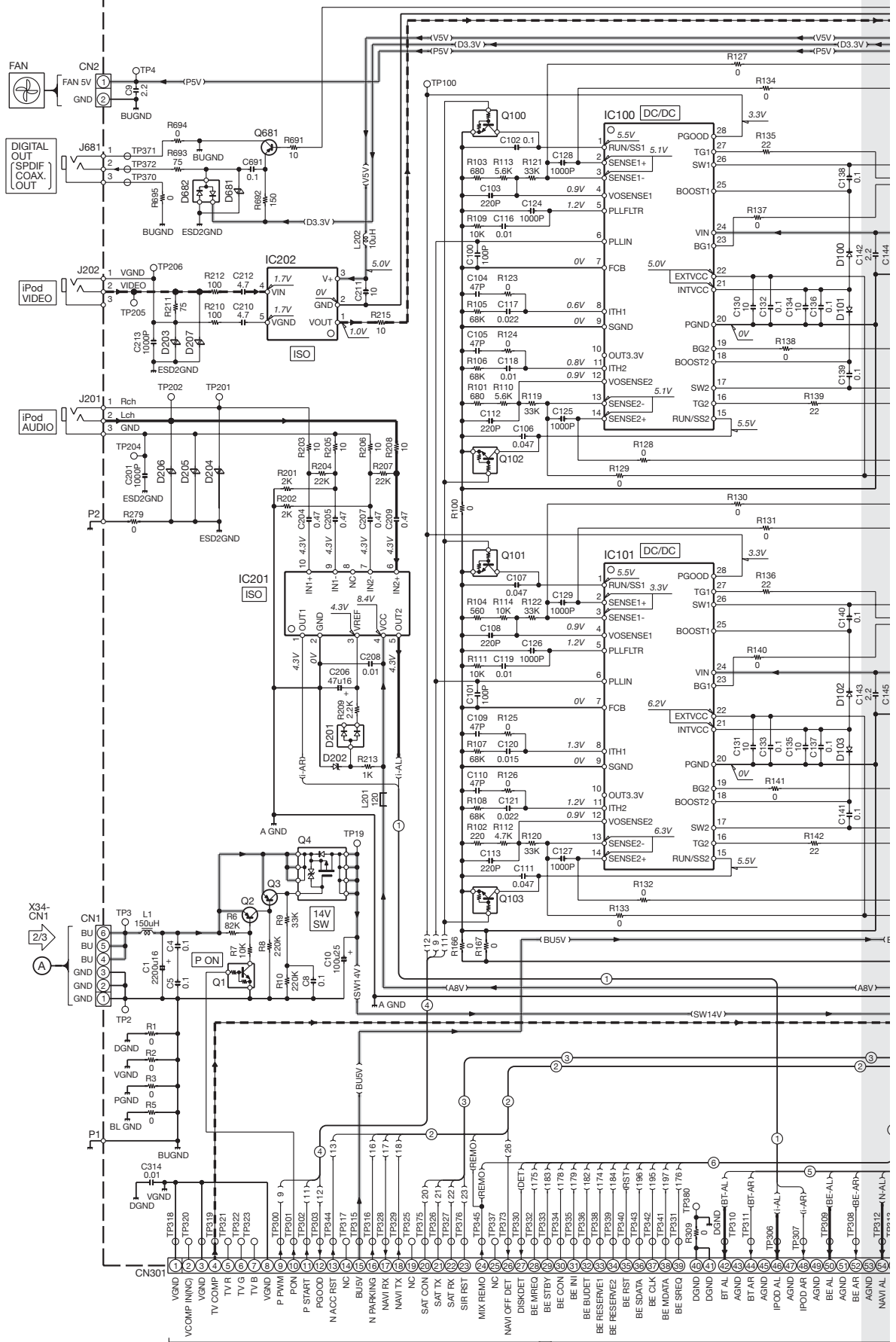

(B) 2/3 X34-CN801

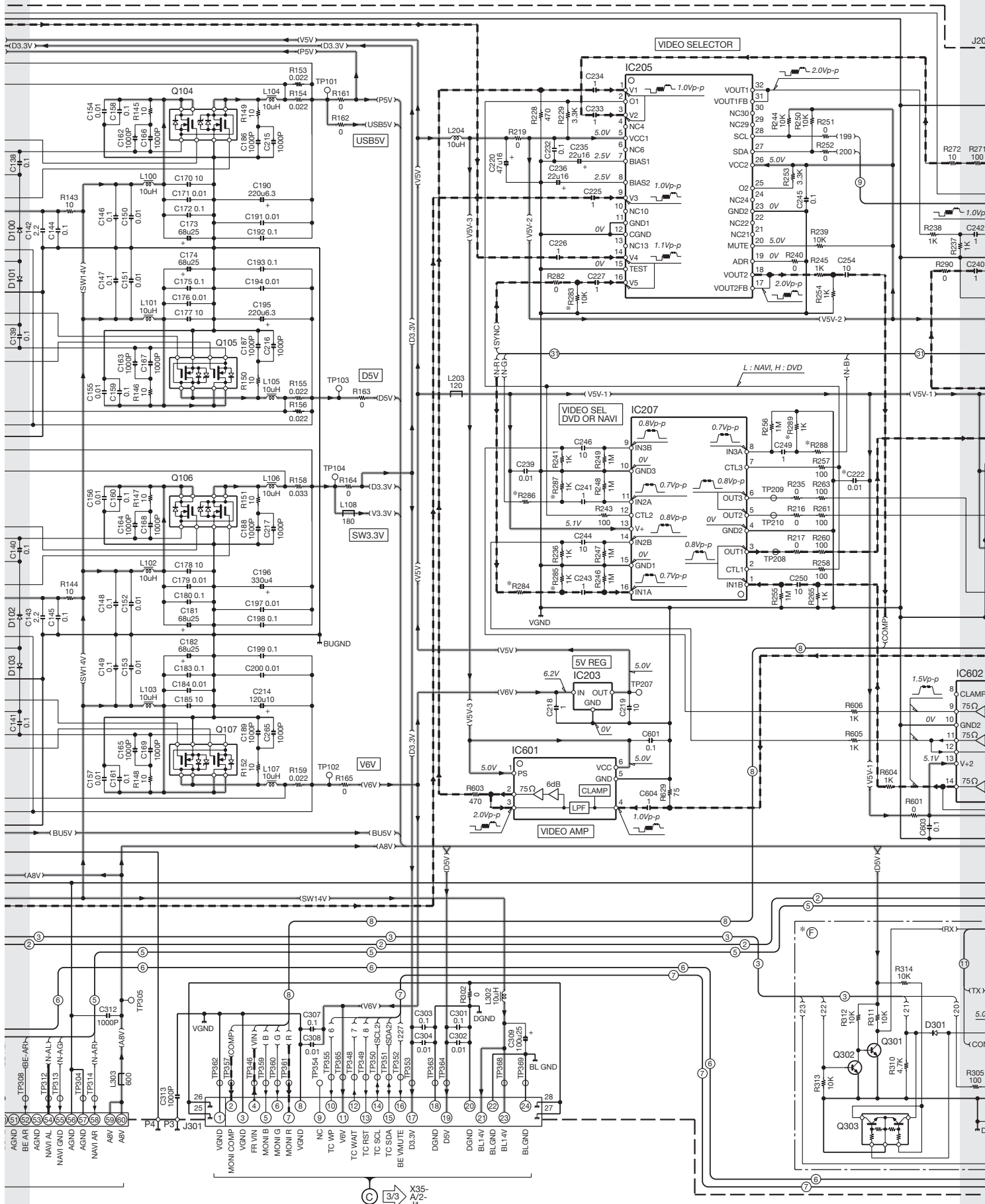

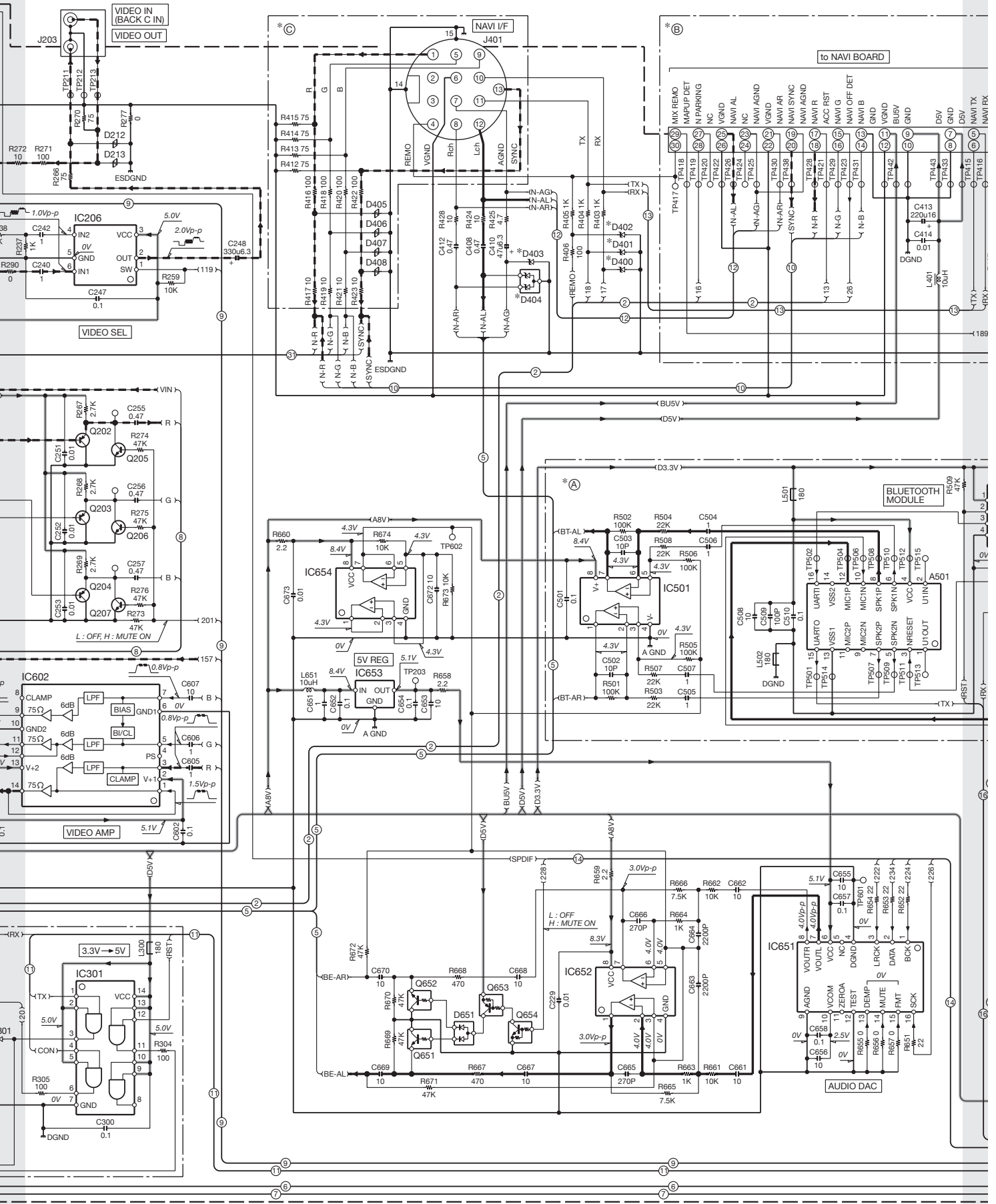

DDX5022/5022Y/5032/5032M/512/52RY DNX5120/512EX/5220/5220BT

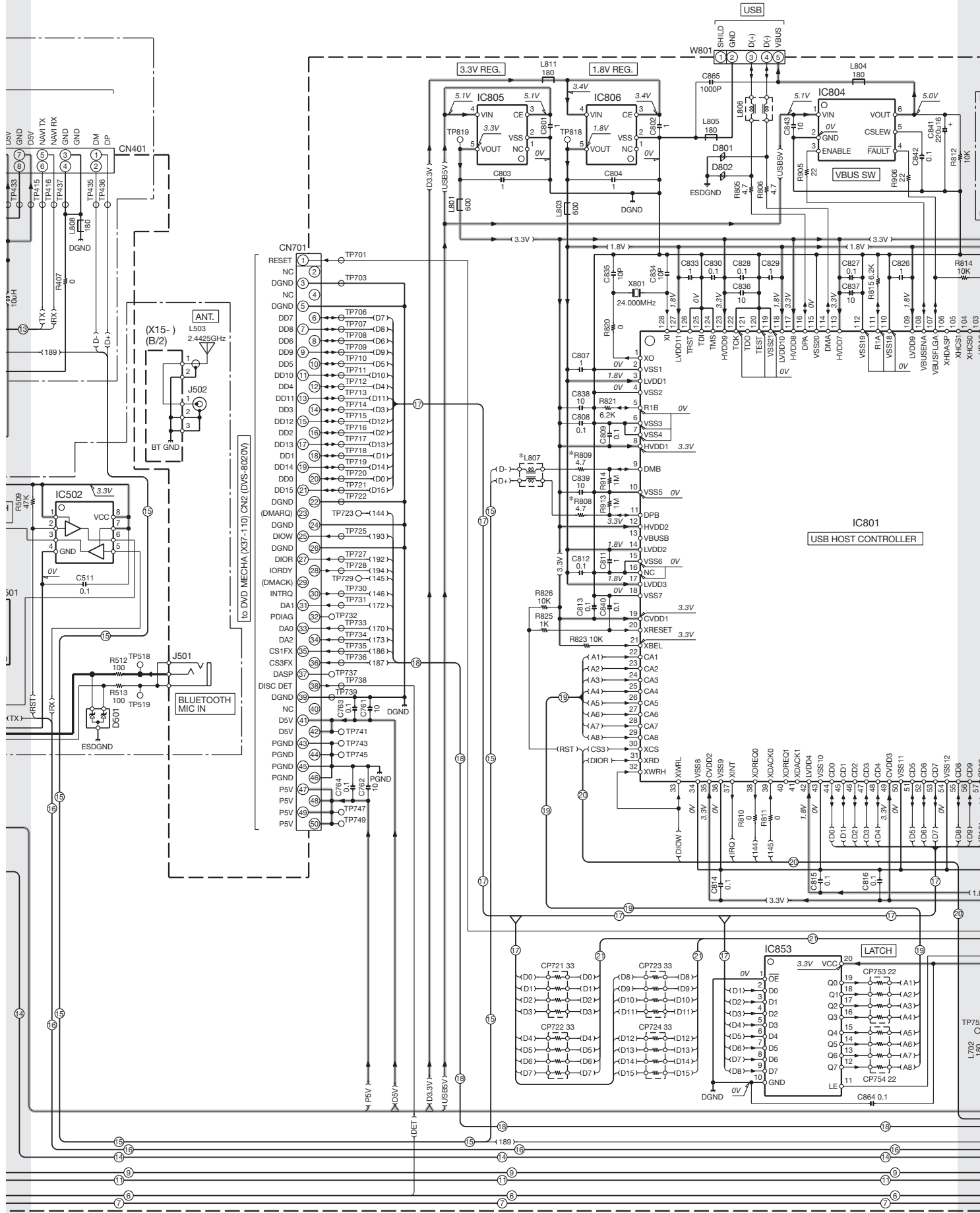

DDX5022/5022Y/5032/5032M/512/52RY
 DNX5120/512EX/5220/5220BT

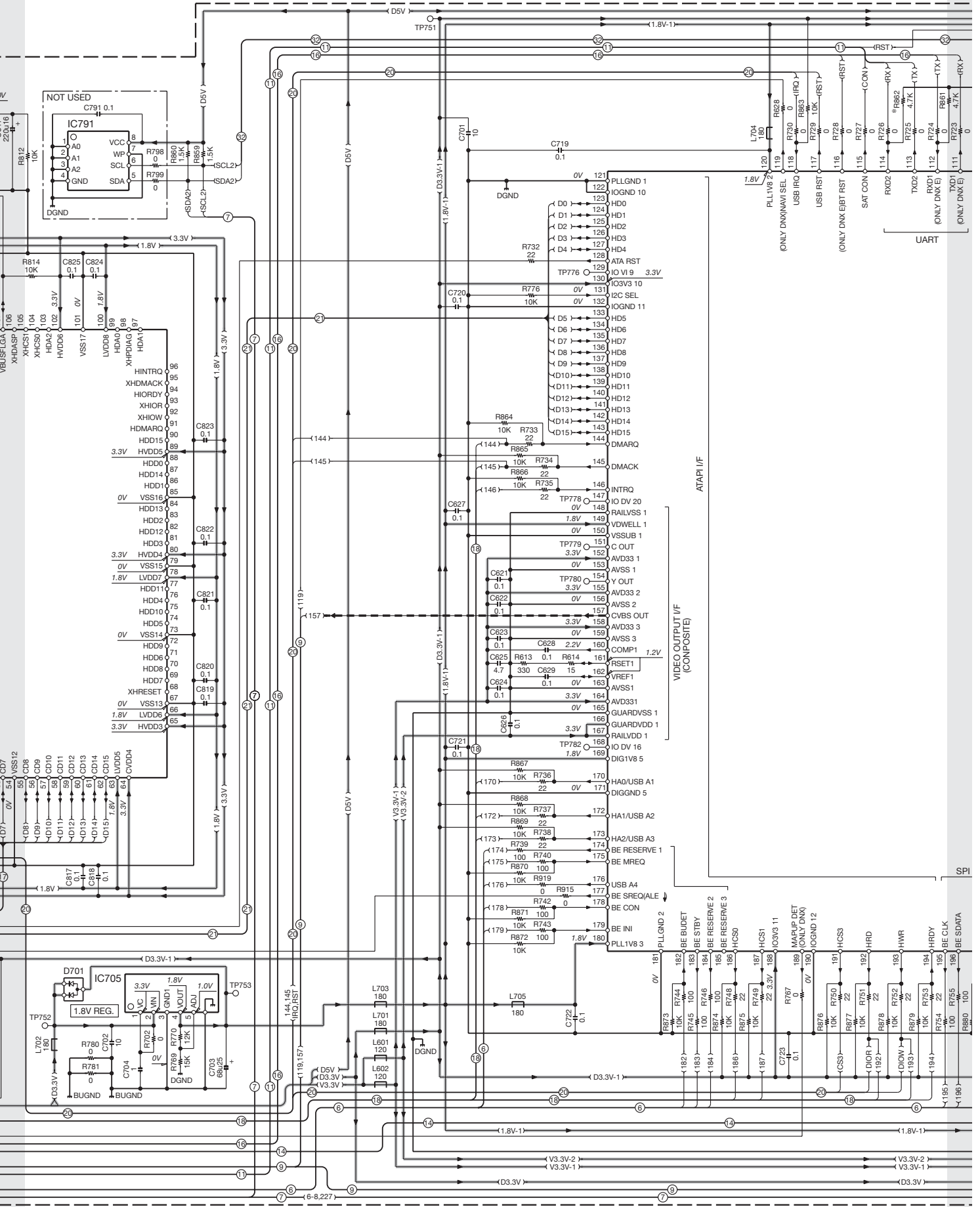

DDX5022/5022Y/5032/5032M/512/52RY DNX5120/512EX/5220/5220BT

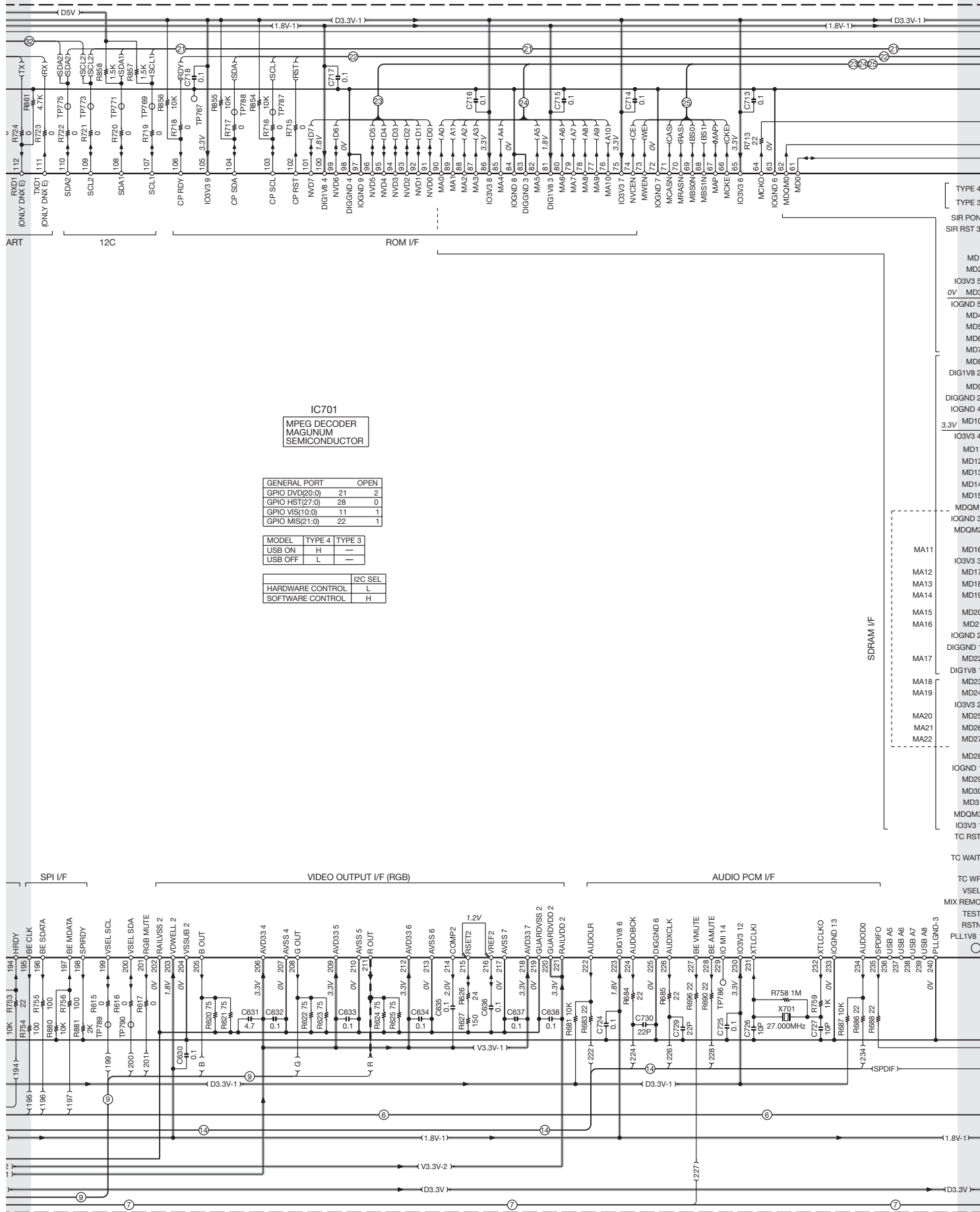

IC701

MPEG DECODER
MAGNUM
SEMICONDUCTOR

GENERAL PORT	OPEN
GPIO DVD(20:0)	21 2
GPIO HST(27:0)	28 0
GPIO VIS(10:0)	11 1
GPIO MIS(21:0)	22 1

MODEL	TYPE 4	TYPE 3
USB ON	H	—
USB OFF	L	—

	12C SEL
HARDWARE CONTROL	L
SOFTWARE CONTROL	H

- TYPE 4
- TYPE 3
- SIR PON
- SIR RST 3
- MD1
- MD2
- IO3V3 5
- OV_ MD3
- IOGND 5
- MD4
- MD5
- MD6
- MD7
- MD8
- DIG1V8 2
- MD9
- DIGGND 2
- IOGND 4
- 3.3V MD10
- IO3V3 4
- MD11
- MD12
- MD13
- MD14
- MD15
- MDOM1
- IOGND 3
- MDOM2
- MA11
- MD16
- IO3V3 3
- MD17
- MA12
- MD18
- MD19
- MA13
- MD20
- MA14
- MD21
- MA15
- MD22
- MA16
- IOGND 1
- DIGGND 1
- MA17
- MD23
- DIG1V8 1
- MD24
- MA18
- MD25
- IO3V3 2
- MA19
- MD26
- MA20
- MD27
- MA21
- MD28
- MA22
- MD29
- IOGND 2
- MD29
- MD30
- MD31
- MDOM3
- IO3V3 1
- TC RST
- TC WAIT
- TC WP
- VSEL
- MIX REMO
- TEST
- RSTN
- PLL1V8 1

SDRAM I/F

DDX5022/5022Y/5032/5032M/512/52RY DNX5120/512EX/5220/5220BT

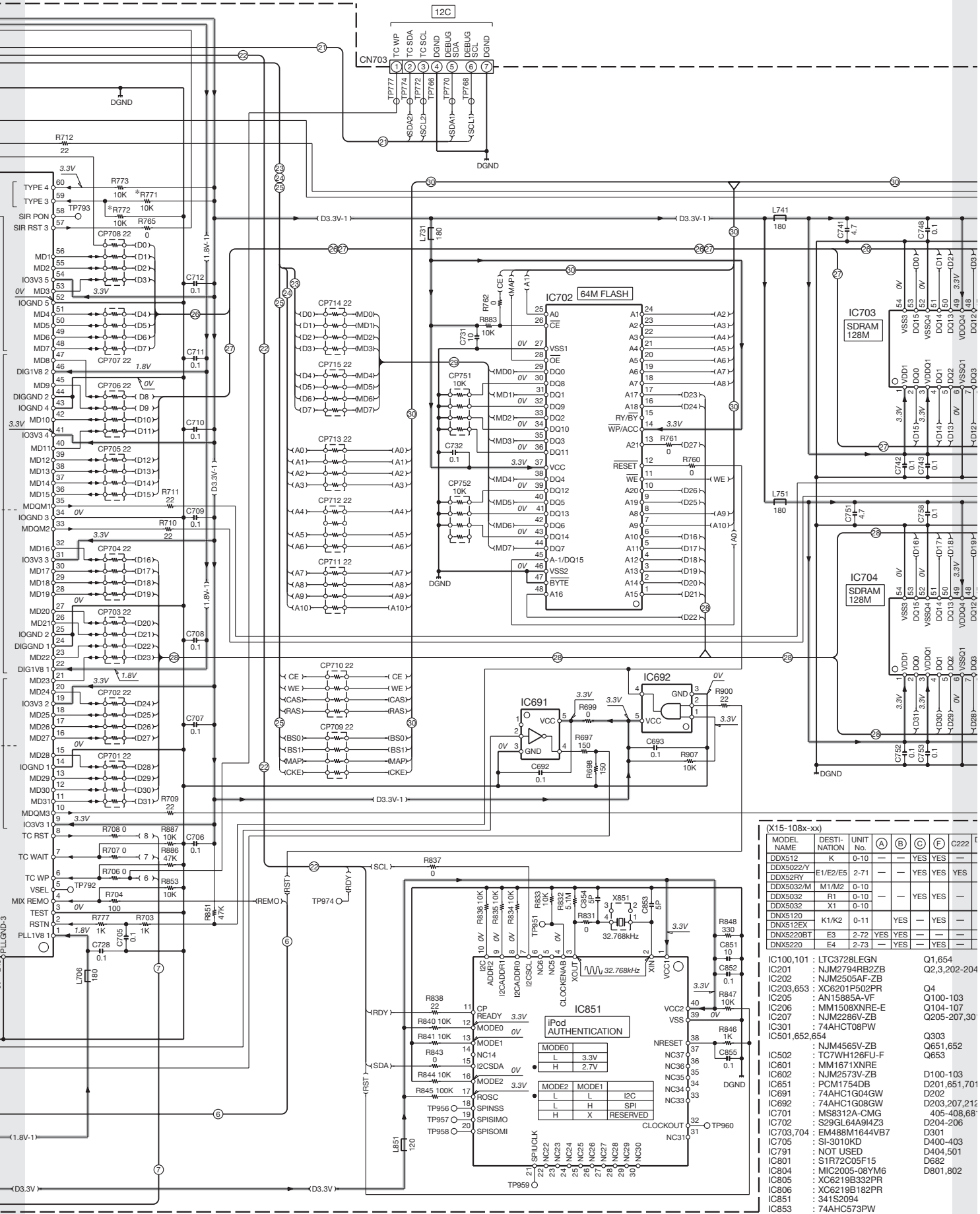

MODEL NAME	DESTINATION	UNIT No.	(A)	(B)	(C)	(F)	C222
DDX512	K	0-10	-	-	YES	YES	-
DDX5022Y	E1/E2/E5	2-71	-	-	YES	YES	-
DDX52RY		0-10	-	-	YES	YES	YES
DDX5032M	M1/M2	0-10	-	-	YES	YES	-
DDX5032	X1	0-10	-	-	YES	YES	-
DDX5032	X1	0-10	-	-	YES	YES	-
DDX5120	K1/K2	0-11	YES	-	YES	-	-
DNX5220BT	E3	2-72	YES	YES	-	-	-
DNX5220	E4	2-73	-	YES	-	-	-

- IC100,101 : LTC3728LEGN Q1,654
- IC201 : NJM2794R82ZB Q2,3,202-204
- IC202 : NJM2505AF-ZB
- IC203,653 : XC6201P502PR Q4
- IC205 : AN15885A-VF Q100-103
- IC206 : MM1508XNRE-E Q104-107
- IC207 : NJM2286V-ZB Q205-207,30
- IC301 : 74AHC108PW
- IC501,652,654 : Q303
- IC502 : NJM4565V-ZB Q651,652
- IC601 : TC7WH126FU-F Q653
- IC602 : MM1671XNRE
- IC602 : NJM2573V-ZB
- IC651 : PCM1754DB D100-103
- IC691 : 74AHC1G04GW D202
- IC692 : 74AHC1G08GW D203,207,212
- IC701 : MS8312A-CMG 405-408,68
- IC702 : S29GL64A9I4Z3 D204-206
- IC703,704 : EM488M1644VB7 D301
- IC705 : SI-3010KD D400-403
- IC791 : NOT USED D404,501
- IC801 : S1R72C05F15 D682
- IC804 : MIC2005-08YM6 D801,802
- IC805 : XC6219B332PR
- IC806 : XC6219B182PR
- IC851 : 341S2094
- IC853 : 74AHC573PW

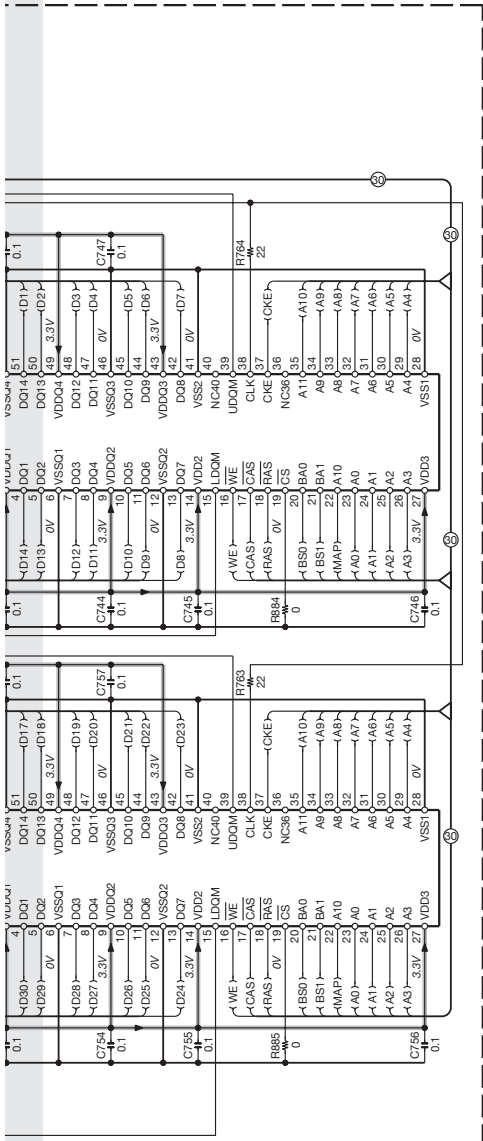

⊕	C222	D400-404	L807	R283,285,287,289,808,809	R284,286,288	R771	R772	R662
YES	—	YES	—	—	0	YES	—	—
YES	YES	YES	—	—	0	YES	—	—
YES	—	YES	—	—	0	YES	—	—
YES	—	—	YES	YES	1K	—	YES	—
—	—	—	YES	YES	1K	YES	—	YES
YES	—	—	YES	YES	1K	—	YES	—

- ⊕1,654 : DTC143ZUA
- ⊕2,3,202-204,681 : 2SA1576A
- ⊕4 : TPC8110-F
- ⊕100-103 : DTC124XUA
- ⊕104-107 : HAT2218R-E
- ⊕205-207,301,302 : 2SC4081
- ⊕303 : UMG2N
- ⊕651,652 : DTC643TU
- ⊕653 : DTA114EUA

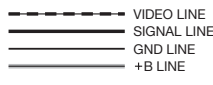

- ⊕100-103 : 1SS357-F
- ⊕201,651,701 : DAP202U
- ⊕202 : UDZS4.7B
- ⊕203,207,212,213,405-408,681 : CVL10C270M300
- ⊕204-206 : CVS10A120M
- ⊕301 : 1SS355
- ⊕400-403 : UDZS6.2B
- ⊕404,501 : STZ6.8N
- ⊕682 : DA204U
- ⊕801,802 : AVRL1613R3FTA

- DTA143XE
- DTA143ZE
- DTA144EUA
- DTC114EE
- DTC143TUA
- 2SA1576A



2SC4081

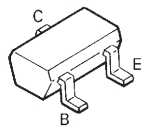

TA75W558FU-F

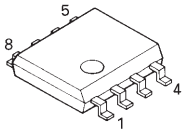

KTA1046-P

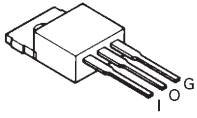

2SK3019



TC7WHU04FU-F
TC7WH126FU-F

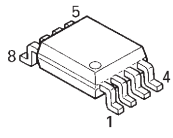

XC6201P502MR

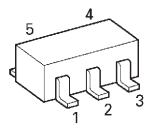

- 2SB1188
- 2SC3357-A

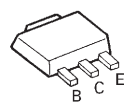

- DTA114EUA
- DTA114TUA
- DTA124EUA
- DTC123JUA
- DTC124EUA
- DTC143EUA
- DTC144EUA

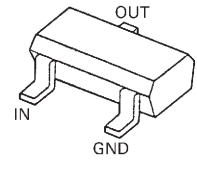

DAN202U



- DAP202U
- DA204U
- DTA114YUA



M5237ML-CF0J

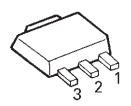

TC7WH74FU-F

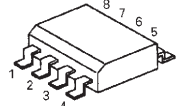

CAUTION : For continued safety, replace safety critical components only with manufacturer's recommended parts (refer to parts list).
 ⊕Indicates safety critical components. To reduce the risk of electric shock, leakage-current or resistance measurements shall be carried out (exposed parts are acceptably insulated from the supply circuit) before the appliance is returned to the customer.

- DC voltages are as measured with a high impedance voltmeter. Values may vary slightly due to variations between individual instruments or/and units.

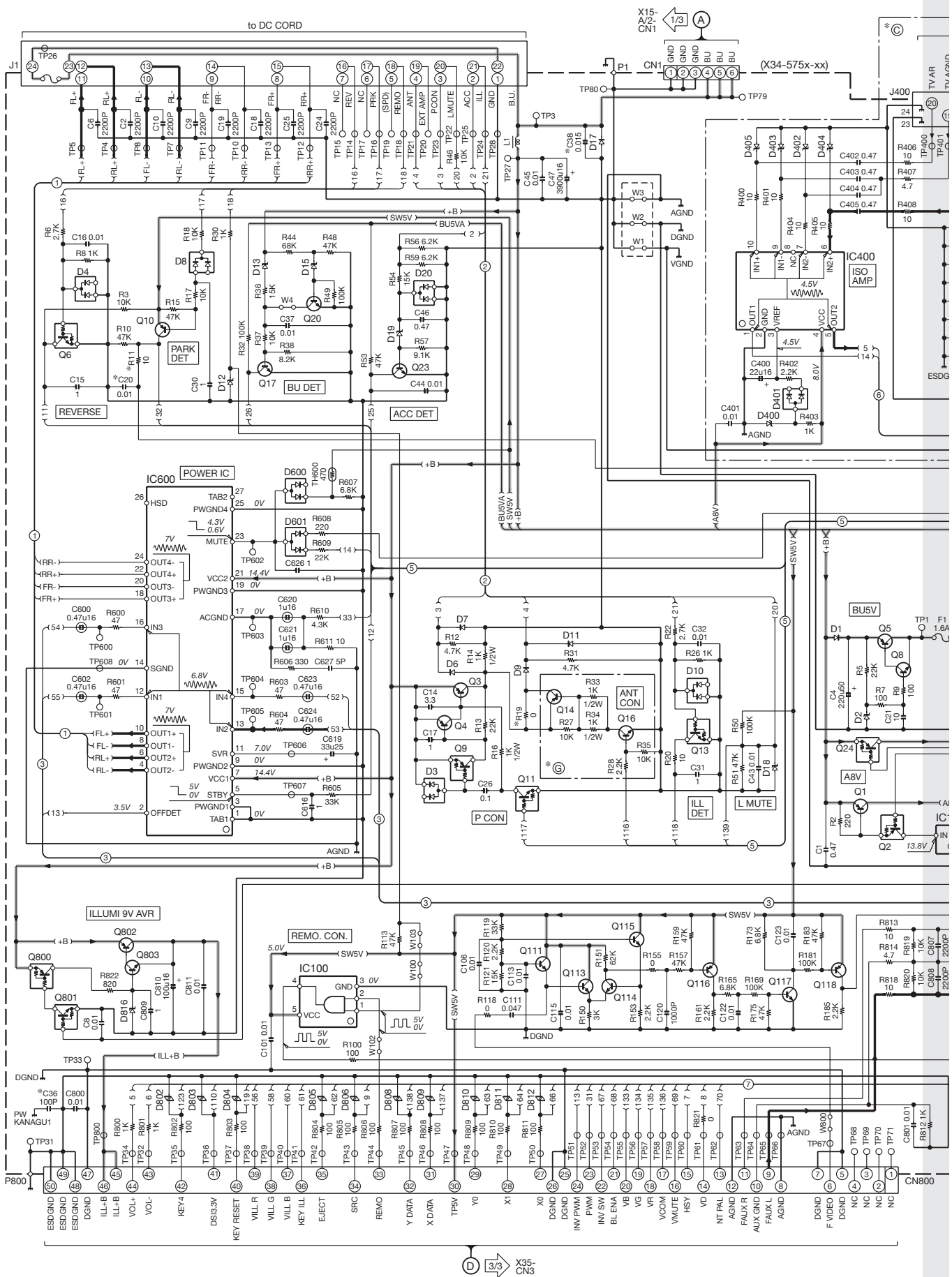

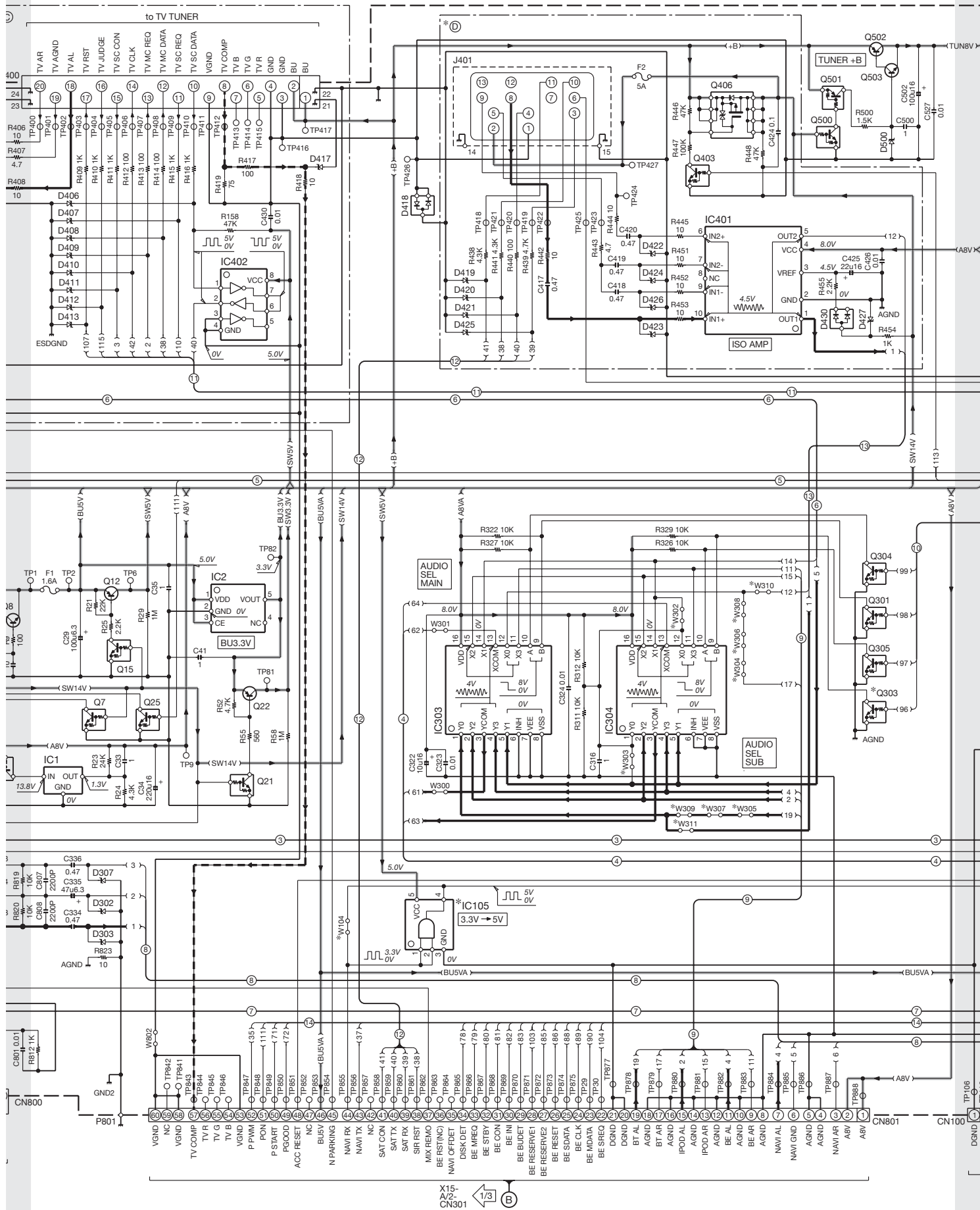

X15-
A/2-
CN301

DDX5022/5022Y/5032/5032M/512/52RY
DNX5120/512EX/5220/5220BT

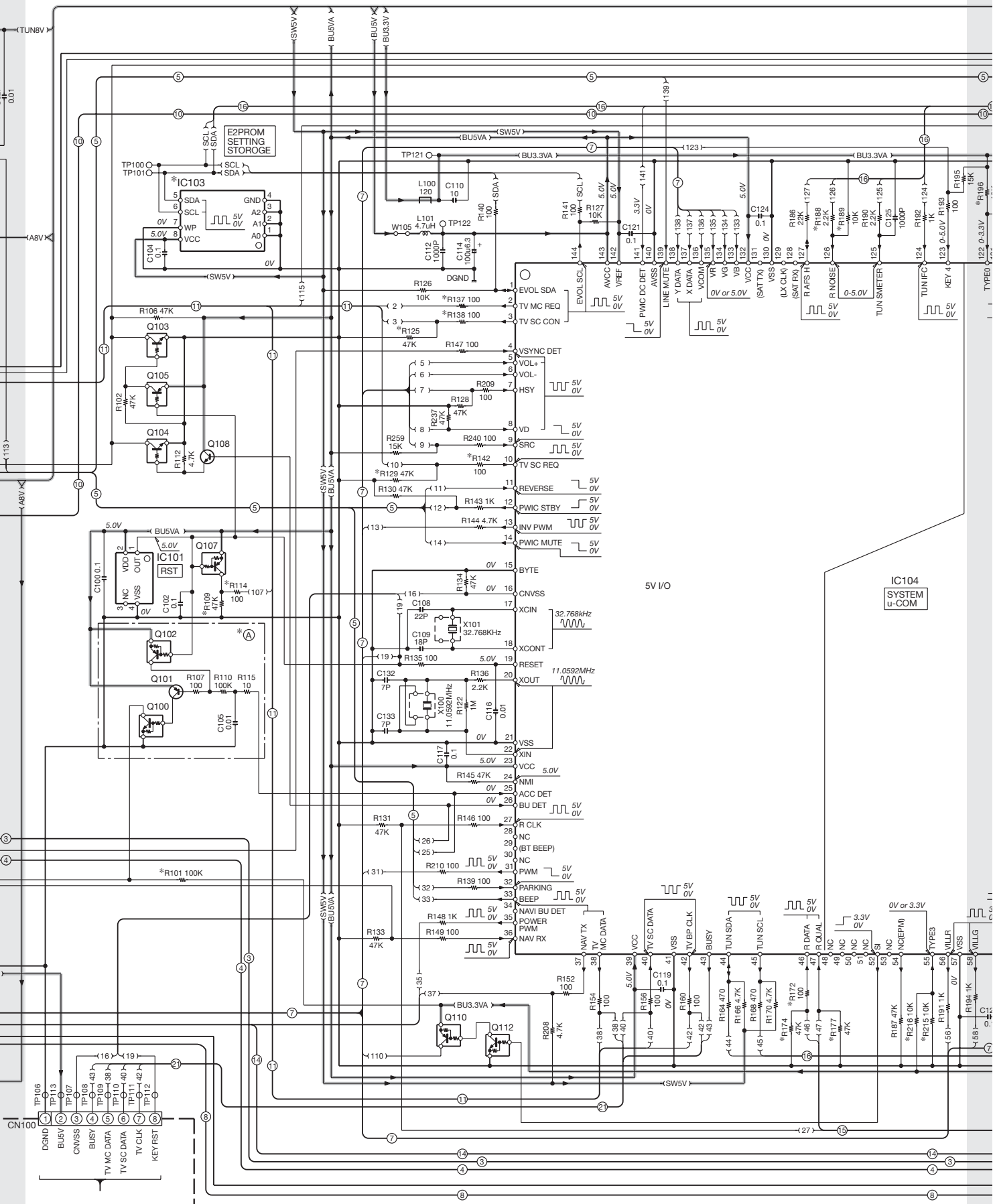

DDX5022/5022Y/5032/5032M/512/52RY
DNX5120/512EX/5220/5220BT

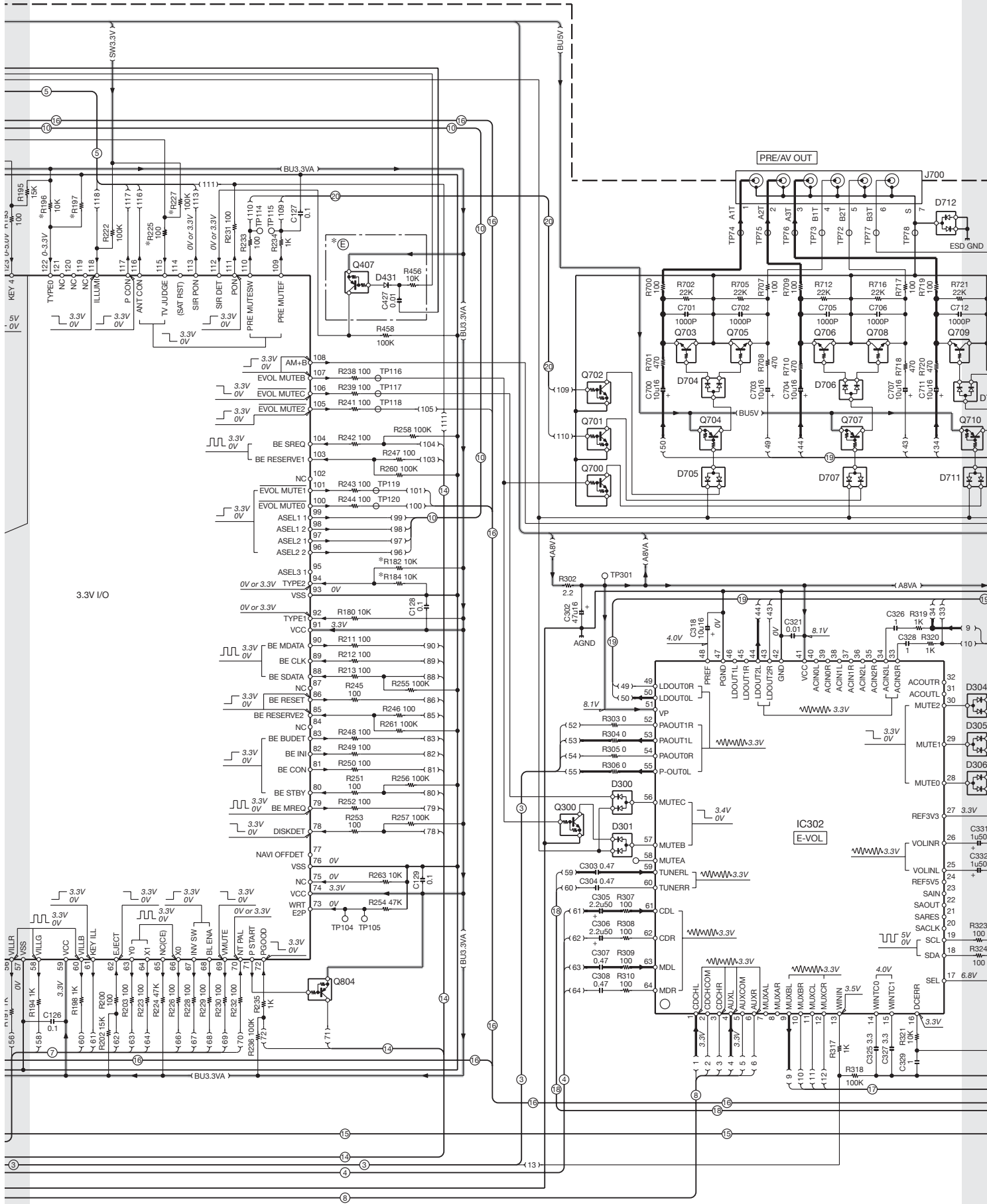

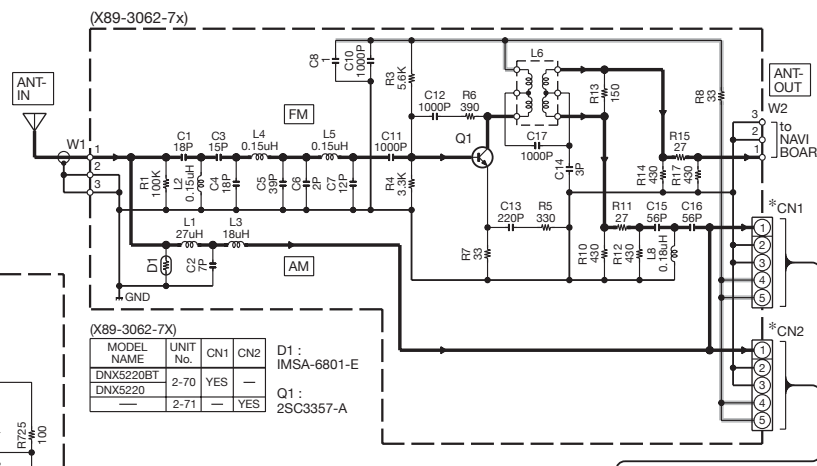

MODEL NAME	UNIT No.	CN1	CN2
DNX5220BT	2-70	YES	—
DNX5220	2-71	—	YES

D1 : IMSA-6801-E
Q1 : 2SC3357-A

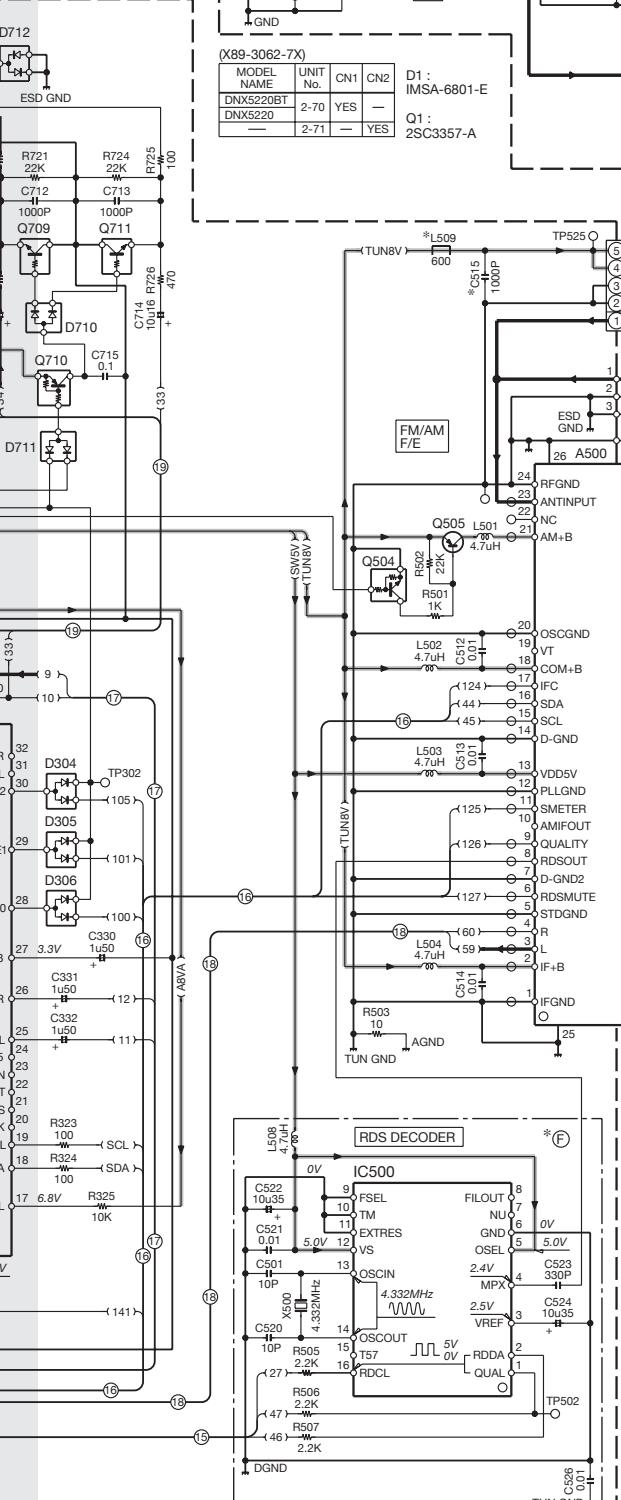

- IC1 : M5237ML-CF0J
 - IC2 : R1114N331B-TR
 - IC100 : 74AHC1G08GW
 - IC101 : S-80835CNNB-G
 - IC103 : *
 - IC104 : 30878MJA21GP
 - IC105 : 74AHC1G08GW
 - IC302 : E-TDA7415CB
 - IC303,304 : TC4052BFT
 - IC400,401 : NJM2794RB2ZB
 - IC402 : TC7WHU04FU-F
 - IC500 : E-TDA7478AD
 - IC600 : E-TDA7850A
- Q1,5,802 : KTA1046-P
 - Q2,24 : DTA124EUA
 - Q3,14 : 2SB1188(R)
 - Q4,10,101,116,118 : *
 - Q6 : 2SA1576A
 - Q7,15,21,100,500,801 : DTC144EUA
 - Q8,16,17,20,23,108,111,113-115,117,503,803 : 2SC4081
 - Q9,102,107 : DTA114EUA
 - Q11,25,112,300,301,303-305,403,504,700-702 : DTC143ZUA
 - Q12,22 : 2SB1689
 - Q13 : DTC124EUA
 - Q103,104 : DTC114TUA
 - Q105 : DTA114TUA
 - Q110,407 : DTA114YUA
 - Q406 : TPC8110-F
 - Q501,704,707,710,800 : DTA144EUA
 - Q502 : 2SB1449(R)-E
 - Q505 : 2SA1577
 - Q703,705,706,708,709,711 : DTC143TUA
 - Q804 : DTA124XUA
- D1 : RB160L-40
 - D2 : UDSZ5.6B
 - D3,300,301,304-306,401,430,600,601,704-707,710,711 : DAP202U
 - D4,8,10,20 : DAN202U
 - D6,7,9,11 : 1SR154-400
 - D12,19,402,403,406-413,417,419-421,424-426 : UDSZ5.2B
 - D13,15,302,303,307,404,405,422,423 : UDSZ8.9B
 - D17 : RMZLF-J1NF
 - D18,400,427 : UDSZ4.7B
 - D418,712 : DA204U
 - D431 : 1SS355
 - D500 : UDSZ9.1B
 - D802-806,808-812 : CVS10A120M
 - D816 : UDSZ10B

MODEL NAME	UNIT No.	IC105	IC103	C36,38	C515	Q303	Q303	L509	W302	W304-307,309	W308	W310
DDX512	K	0-10	—	—	—	—	—	—	—	—	—	—
DDX5022	E1	—	—	—	—	—	—	—	—	—	—	—
DDX5022Y	E2	—	—	—	—	—	—	—	—	—	—	—
DDX5032	E5	—	—	—	—	—	—	—	—	—	—	—
DDX5032M	M1	—	—	—	—	—	—	—	—	—	—	—
DDX5032R	R2	—	—	—	—	—	—	—	—	—	—	—
DDX5032	X1	—	—	—	—	—	—	—	—	—	—	—
DDX5120	K1	—	—	—	—	—	—	—	—	—	—	—
DDX5220BT	E3	—	—	—	—	—	—	—	—	—	—	—
DNX5220	E4	—	—	—	—	—	—	—	—	—	—	—

CAUTION : For continued safety, replace safety critical components only with manufacturer's recommended parts (refer to parts list).
 ⚠ Indicates safety critical components. To reduce the risk of electric shock, leakage-current or resistance measurements shall be carried out (exposed parts are acceptably insulated from the supply circuit) before the appliance is returned to the customer.

- DC voltages are as measured with a high impedance voltmeter. Values may vary slightly due to variations between individual instruments or/and units.

DDX5022/5022Y/5032/5032M/512/52RY
DNX5120/512EX/5220/5220BT (2/3)

(X35-4890-10) (A/2)

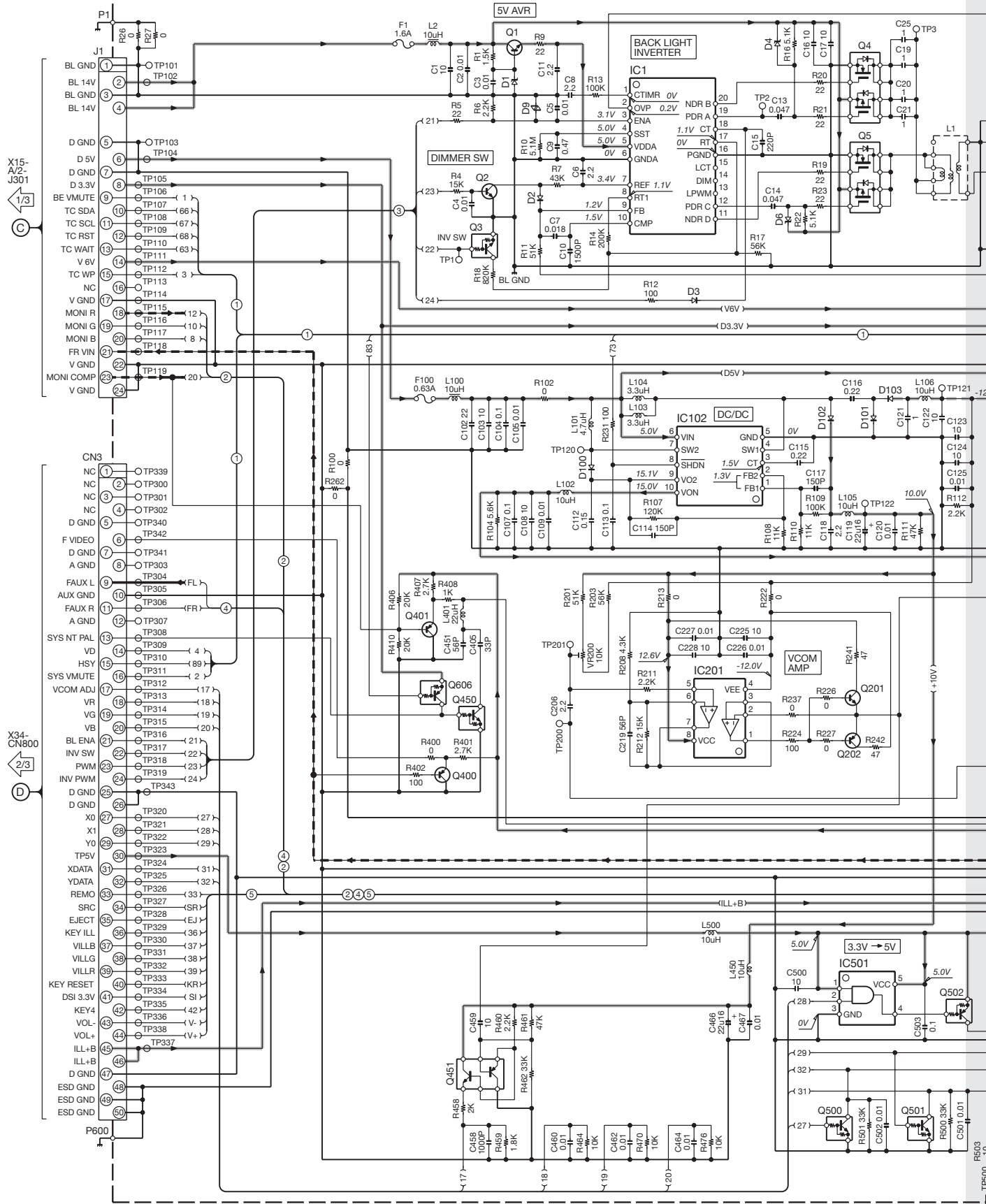

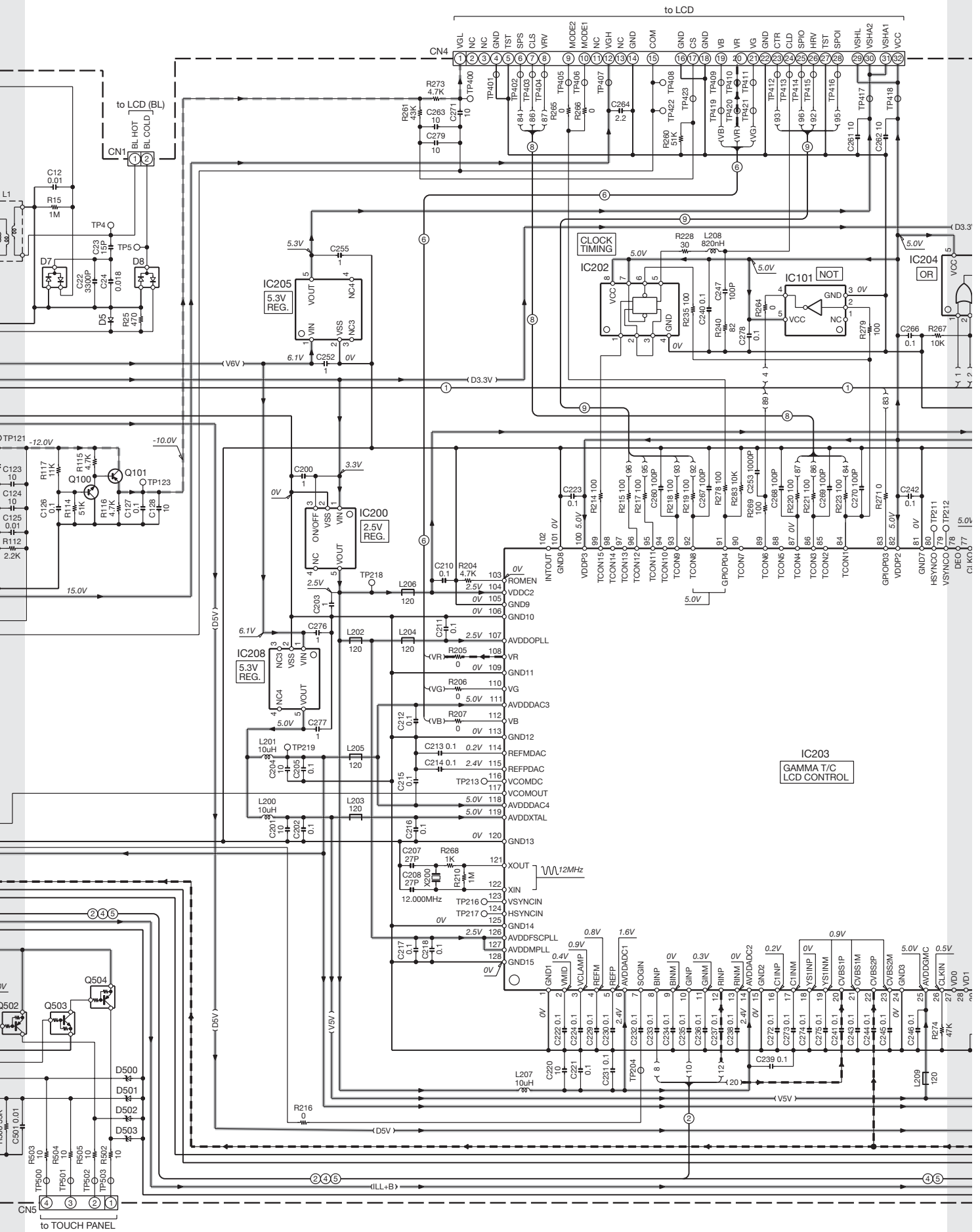

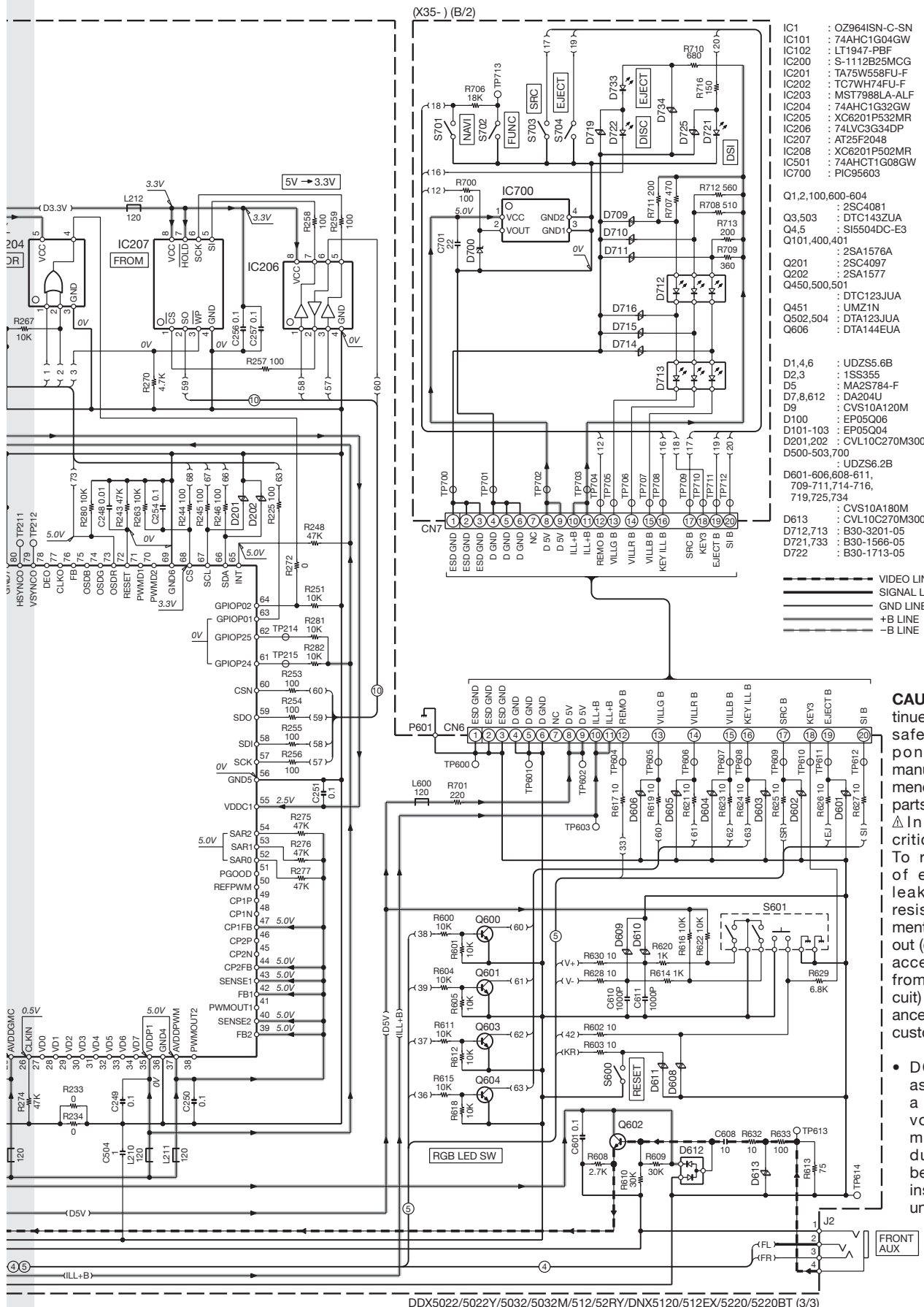

DDX5022/5022Y/5032/5032M/512/52RY/DNX5120/512EX/5220/5220BT (3/3)

CAUTION : For continued safety, replace safety critical components only with manufacturer's recommended parts (refer to parts list). Δ Indicates safety critical components. To reduce the risk of electric shock, leakage-current or resistance measurements shall be carried out (exposed parts are acceptably insulated from the supply circuit) before the appliance is returned to the customer.

- DC voltages are as measured with a high impedance voltmeter. Values may vary slightly due to variations between individual instruments or/and units.

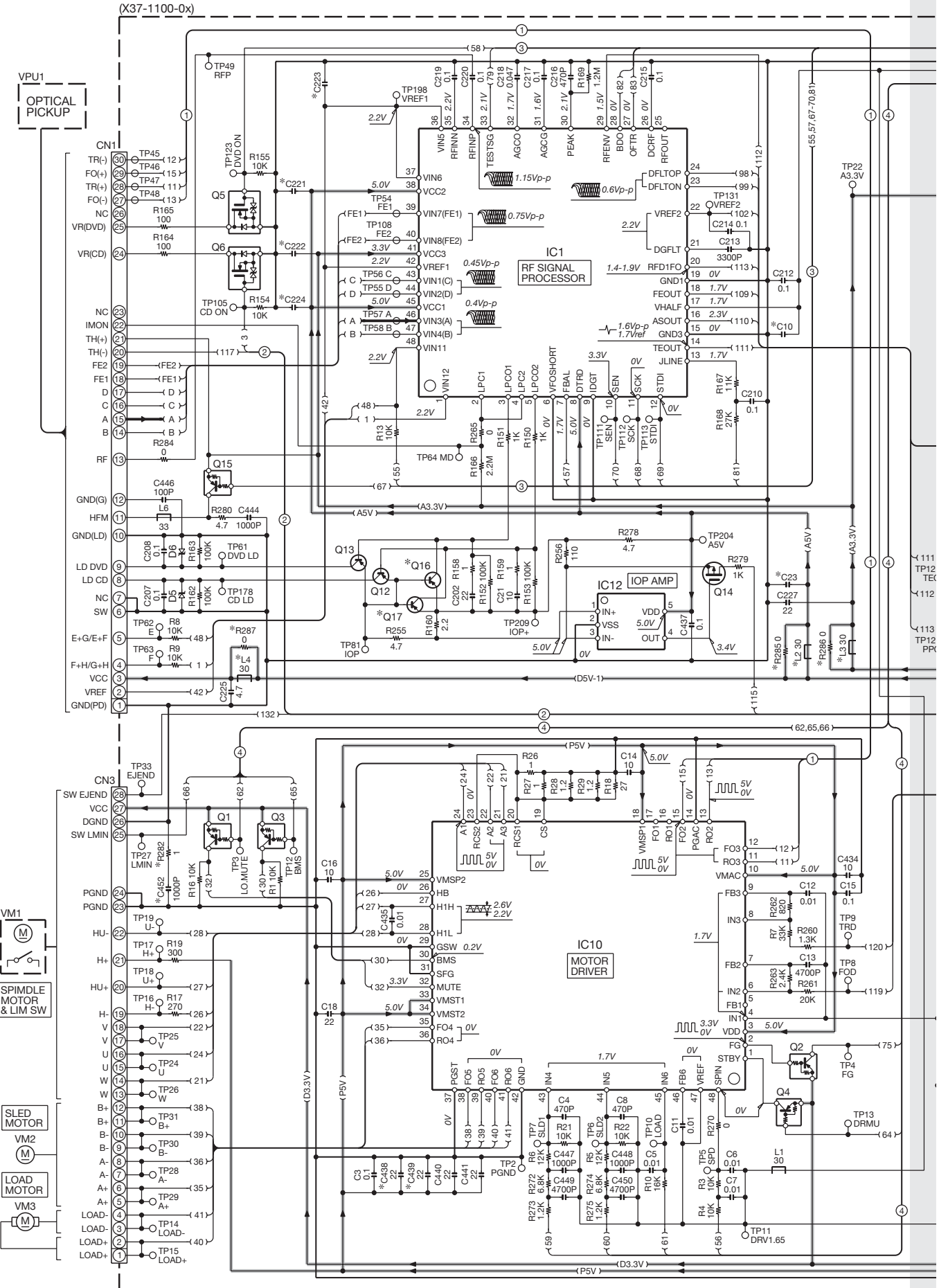

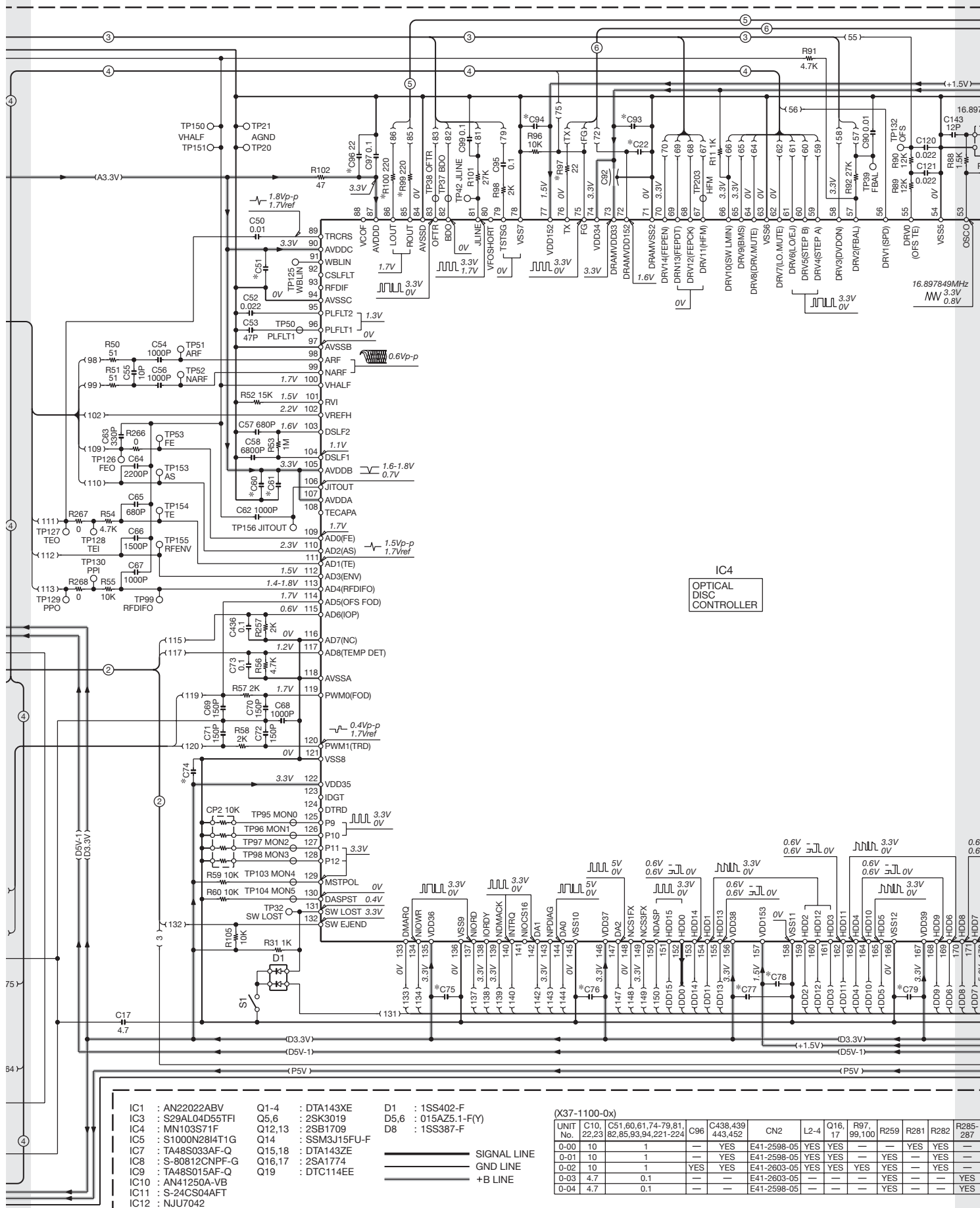
DDX5022/5022Y/5032/5032M/512/52RY
DNX5120/512EX/5220/5220BT

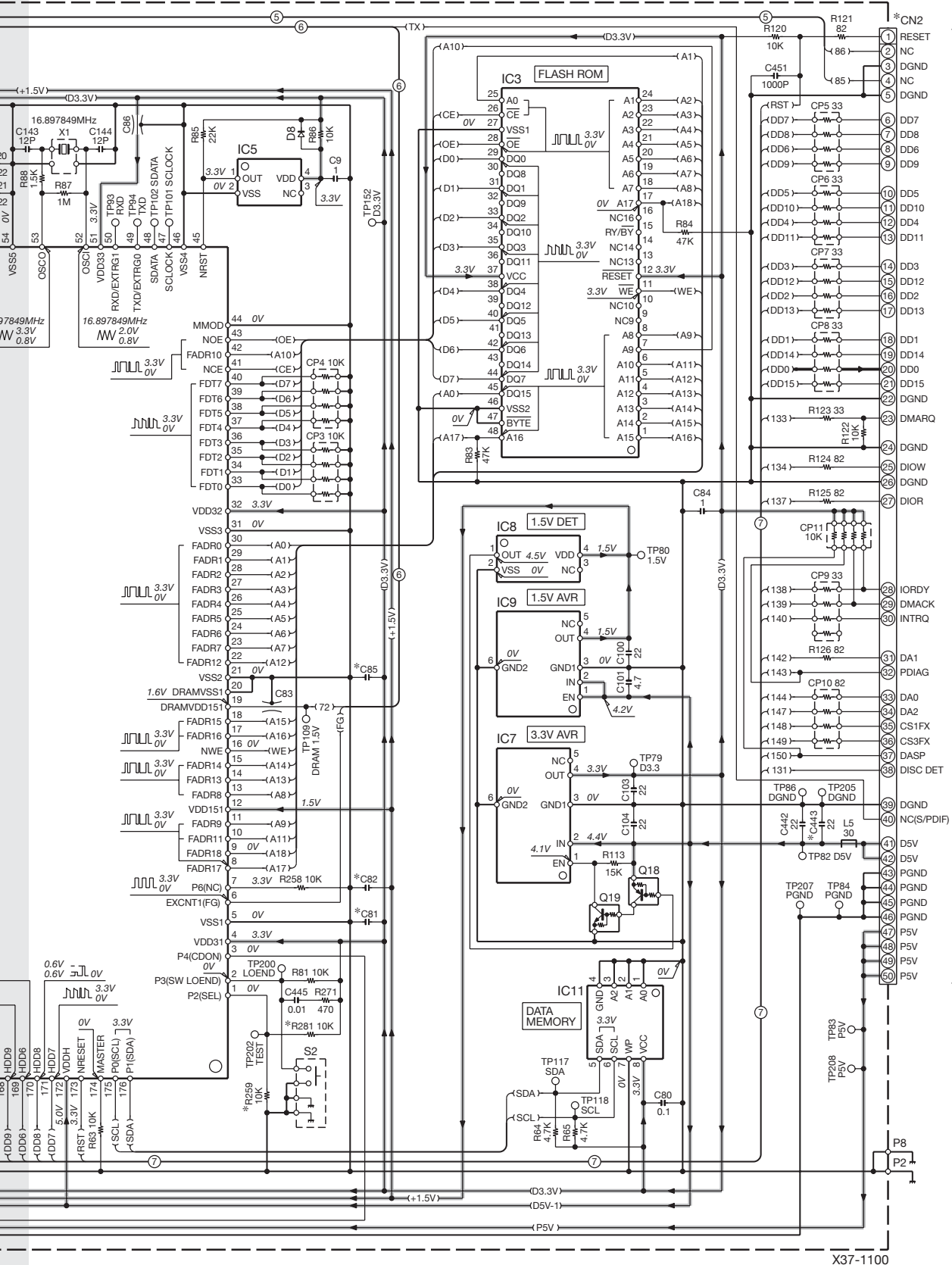

to MAIN UNIT

X37-1100

CAUTION : For continued safety, replace safety critical components only with manufacturer's recommended parts (refer to parts list).

△ Indicates safety critical components. To reduce the risk of electric shock, leakage-current or resistance measurements shall be carried out (exposed parts are acceptably insulated from the supply circuit) before the appliance is returned to the customer.

- DC voltages are as measured with a high impedance voltmeter. Values may vary slightly due to variations between individual instruments or/and units.

R282	R285-287
YES	
YES	
YES	
	YES
	YES

1
2
3
4
5
6
7

EXPLODED VIEW (DVD MECHANISM)

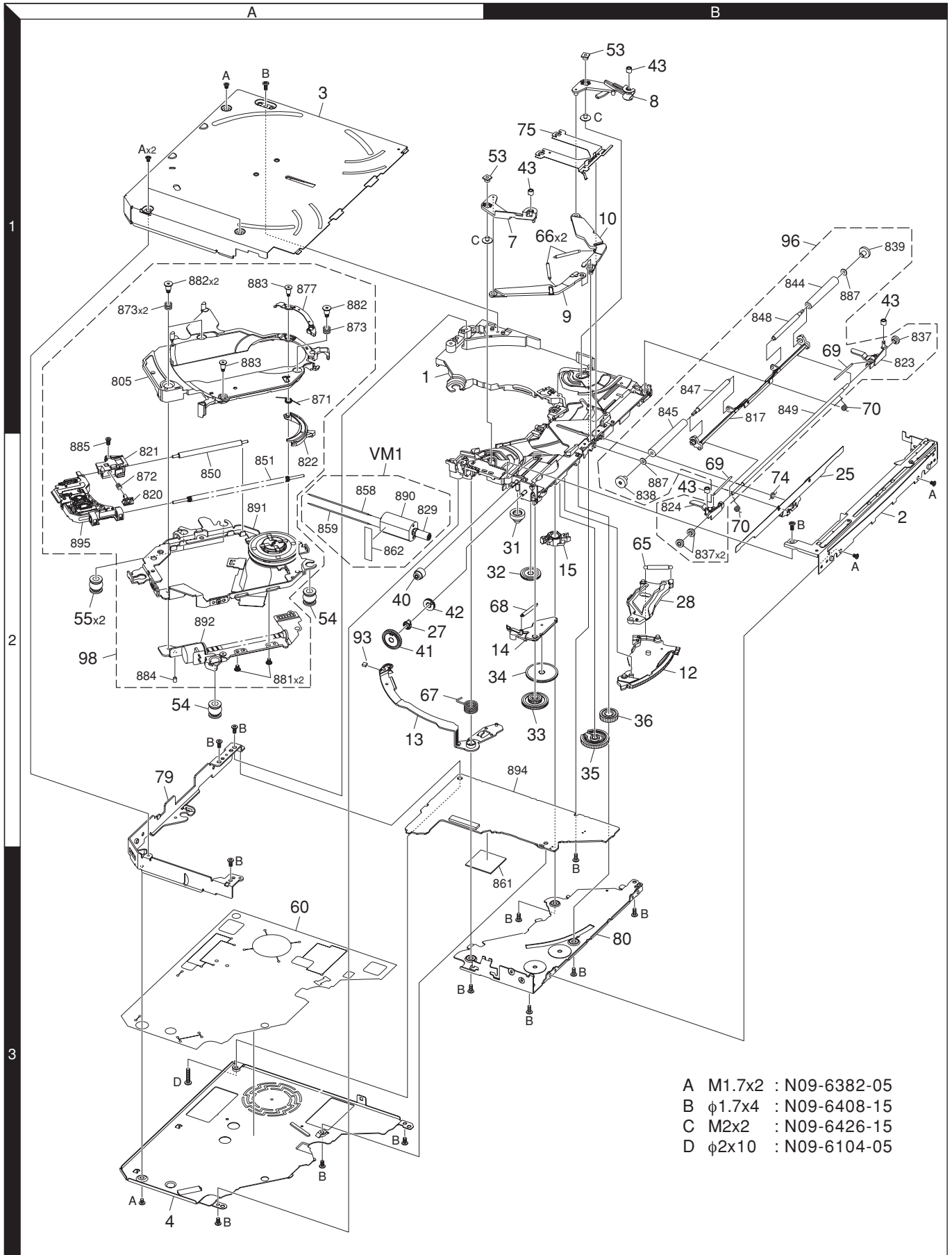

- A M1.7x2 : N09-6382-05
- B φ1.7x4 : N09-6408-15
- C M2x2 : N09-6426-15
- D φ2x10 : N09-6104-05

Parts with the exploded numbers larger than 700 are not supplied.

EXPLODED VIEW (UNIT)

- A M3x14 : N09-6731-05
- B M2.6x4 : N35-2604-43
- C M2.6x20 : N35-2620-48
- E φ2.6x5 : N86-2605-48
- F M2x3 : N35-2003-48
- H φ2.6x8 : N82-2608-48
- K φ3x8 : N09-6727-05
- L φ3x8 : N82-3008-48

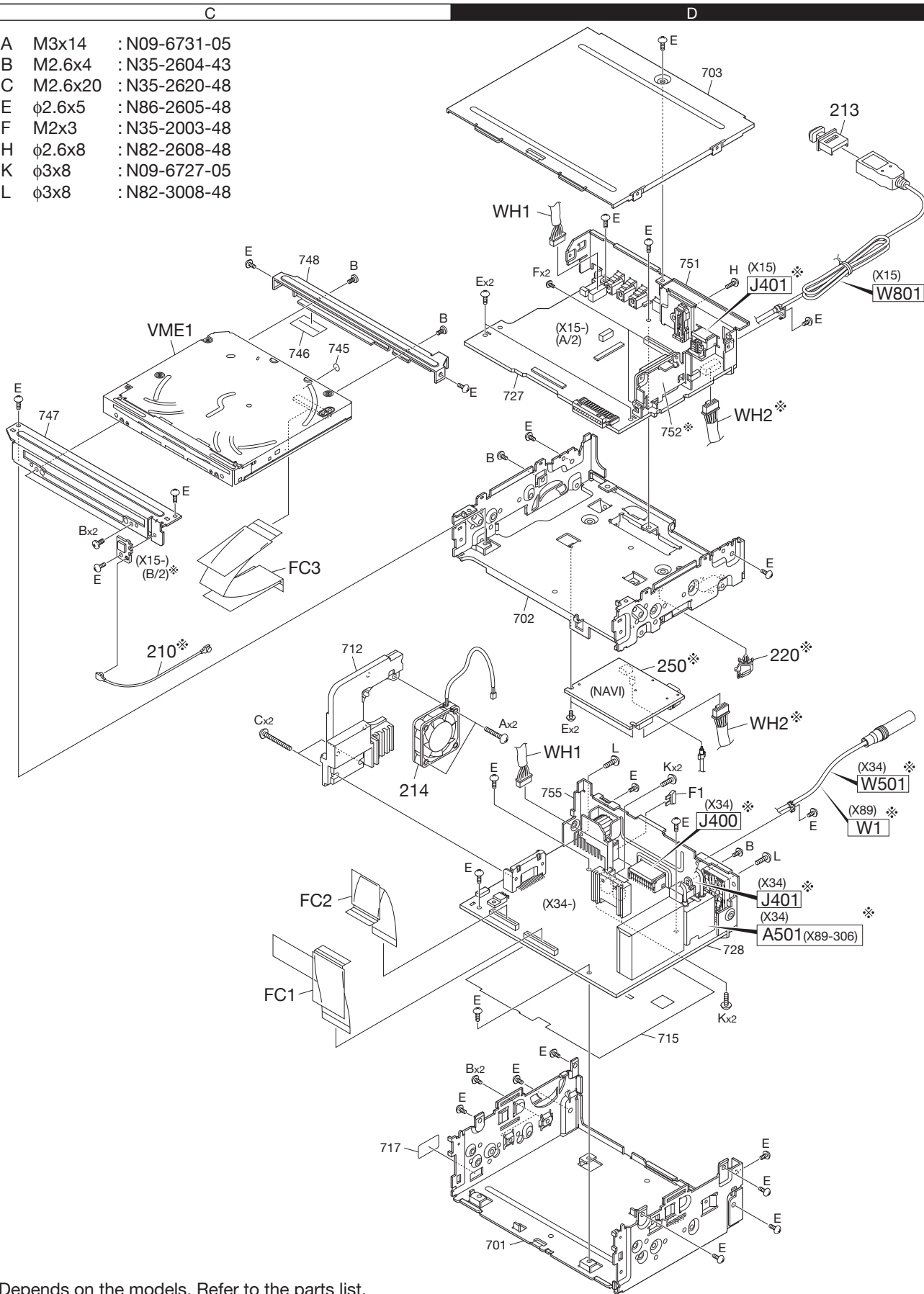

※ Depends on the models. Refer to the parts list.

Parts with the exploded numbers larger than 700 are not supplied.

EXPLODED VIEW (PANEL MECHANISM)

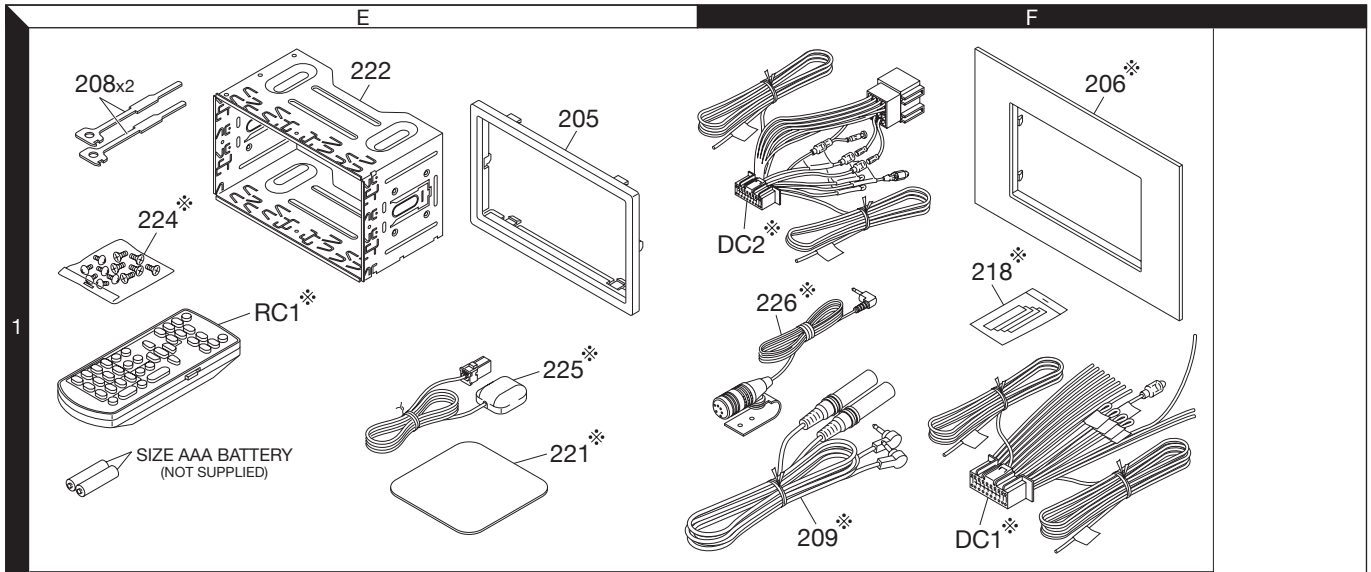

- D ϕ 2.6x6 : N78-2660-48
- F M2x3 : N35-2003-48
- G ϕ 2x8 : N80-2008-43

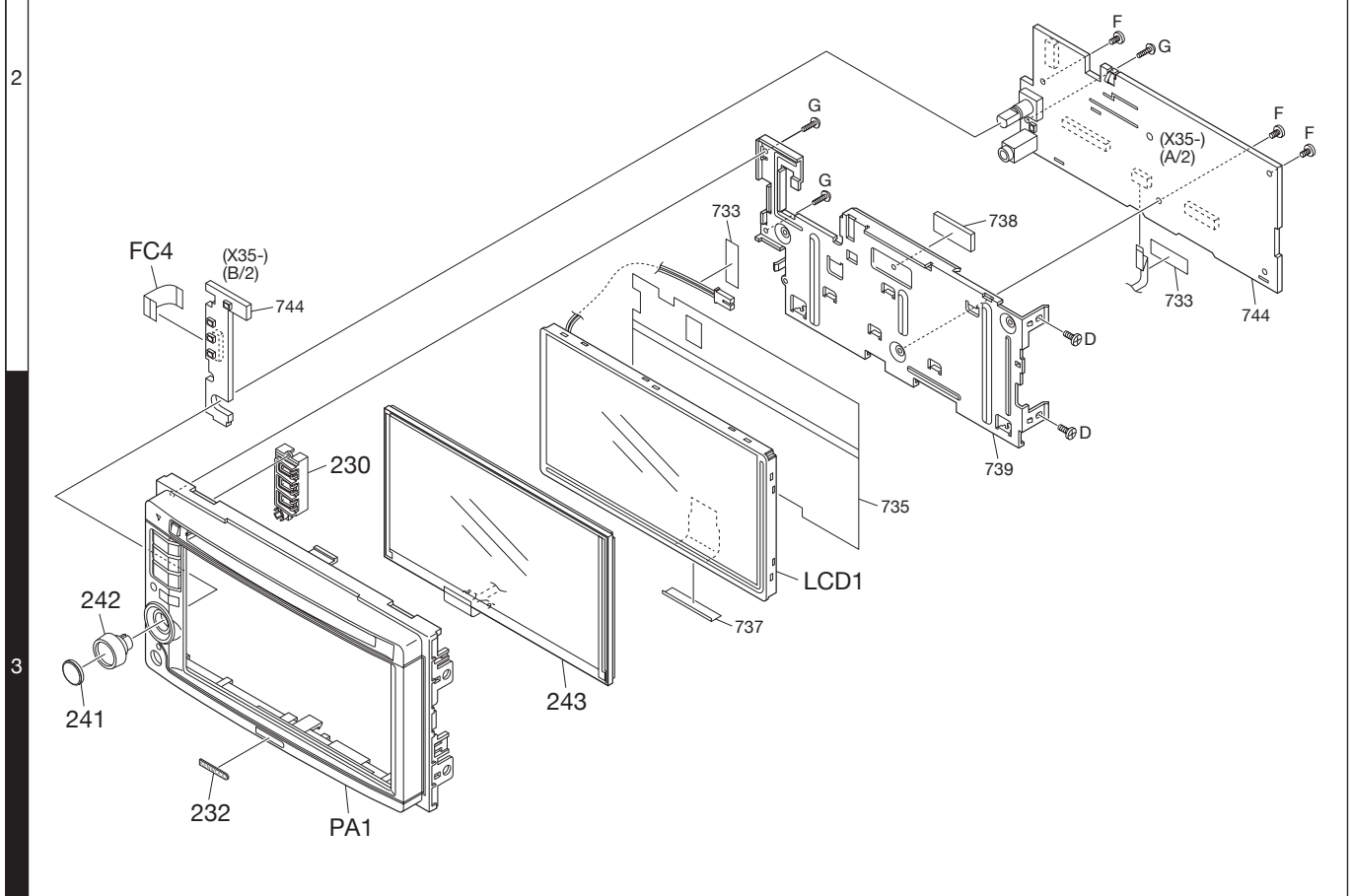

* Depends on the models. Refer to the parts list.

Parts with the exploded numbers larger than 700 are not supplied.

PARTS LIST

* New parts
 Parts without **Parts No.** are not supplied.
 Les articles non mentionnés dans le **Parts No.** ne sont pas fournis.
 Teile ohne **Parts No.** werden nicht geliefert.

Ref. No.	A d d	N e w	Parts No.	Description	Desti- nation
DDX5022/5022Y/5032/5032M/512/52RY DNX5120/512EX/5220/5220BT					
RC1	1E		A70-2083-15	REMOTE CONTROLLER ASSY	E2M1M2
RC1	1E		A70-2083-15	REMOTE CONTROLLER ASSY	X1E5
-		*	B54-4618-00	INSTALLATION MANUA (ENG.FRE.SPA	KR1
-		*	B54-4619-00	INSTALLATION MANUAL (PORTUGUESE	R1
-		*	B54-4620-00	INSTALLATION MAN (ENG.S-CHI.KOR	M1M2X1
-		*	B54-4621-00	INSTALLATION MANUAL (ENGLISH)	E1E2E5
-		*	B54-4622-00	INSTALLATION MANUA (F.G.D.I.S.P	E1
-		*	B54-4623-00	INSTALLATION MANUAL (RUSSIAN)	E2E5
-		*	B54-4624-00	INSTALLATION MANUA (ENG.FRE.SPA	K1K2
-		*	B54-4626-00	INSTALLATION MAN (E.F.G.D.I.S.P	E3E4
-		*	B64-3971-00	INSTRUCTION MANUAL (ENGLISH)	KR1K1
-		*	B64-3971-00	INSTRUCTION MANUAL (ENGLISH)	K2
-		*	B64-3972-00	INSTRUCTION MANUAL (FRENCH)	KK1K2
-		*	B64-3973-00	INSTRUCTION MANUAL (SPANISH)	KR1K1
-		*	B64-3973-00	INSTRUCTION MANUAL (SPANISH)	K2
-		*	B64-3974-00	INSTRUCTION MANUAL (PORTUGUESE)	R1
-		*	B64-3975-00	INSTRUCTION MANUAL (ENGLISH)	M1M2X1
-		*	B64-3976-00	INSTRUCTION MANUAL (S-CHINESE)	M1
-		*	B64-3977-00	INSTRUCTION MANUAL (KOREAN)	M1
-		*	B64-3978-00	INSTRUCTION MANUAL (ENGLISH)	E1E2E5
-		*	B64-3978-00	INSTRUCTION MANUAL (ENGLISH)	E3E4
-		*	B64-3979-00	INSTRUCTION MANUAL (FRENCH)	E1E3E4
-		*	B64-3980-00	INSTRUCTION MANUAL (GERMAN)	E1E3E4
-		*	B64-3981-00	INSTRUCTION MANUAL (DUTCH)	E1E3E4
-		*	B64-3982-00	INSTRUCTION MANUAL (ITALIAN)	E1E3E4
-		*	B64-3983-00	INSTRUCTION MANUAL (SPANISH)	E1E3E4
-		*	B64-3984-00	INSTRUCTION MANUAL (PORTUGUESE)	E1E3E4
-		*	B64-3985-00	INSTRUCTION MANUAL (RUSSIAN)	E2E5
-		*	B64-4004-00	INSTRUCTION MANUAL (ENGLISH)	K1K2
-		*	B64-4005-00	INSTRUCTION MANUAL (FRE.SPA.)	K1K2
-		*	B64-4006-00	INSTRUCTION MANUAL (ENGLISH)	E3E4
-		*	B64-4007-00	INSTRUCTION MANUAL (FRE.GER.DUT	E3E4
-		*	B64-4008-00	INSTRUCTION MANUAL (ITA.SPA.POR	E3E4
205	1E		B07-3165-02	ESCUTCHEON	
206	1F		B07-3172-12	ESCUTCHEON	KR1M1
206	1F		B07-3172-12	ESCUTCHEON	K2
206	1F		B07-3172-12	ESCUTCHEON	M2X1K1
208	1E		D10-4589-04	LEVER	
209	1F	*	E30-6785-05	CORD WITH PLUG	KR1K1
209	1F	*	E30-6785-05	CORD WITH PLUG	K2
210	2C	*	E30-6810-05	CORD WITH PLUG	E3
DC1	1F	*	E30-6795-05	DC CORD	KR1M1
DC1	1F	*	E30-6795-05	DC CORD	K2
DC1	1F	*	E30-6795-05	DC CORD	M2X1K1
DC2	1F	*	E30-6796-05	DC CORD	E1E2E5
DC2	1F	*	E30-6796-05	DC CORD	E3E4
FC1	3C	*	E39-0995-15	FLAT CABLE	
FC2	3C	*	E39-0996-15	FLAT CABLE	
FC3	2C	*	E39-0997-15	FLAT CABLE	
WH1	1D	*	E39-0994-15	WIRING HARNESS	
213	1D		F09-2929-04	CAP	

Ref. No.	A d d	N e w	Parts No.	Description	Desti- nation
214	2C	*	F09-2959-05	FAN	
F1	2D		F52-0007-05	FUSE (MINI BLADE TYPE) 15A	
-		*	H54-4274-13	ITEM CARTON CASE	K
-		*	H54-4275-13	ITEM CARTON CASE	R1
-		*	H54-4276-13	ITEM CARTON CASE	E1
-		*	H54-4277-13	ITEM CARTON CASE	E2
-		*	H54-4278-13	ITEM CARTON CASE	M1X1
-		*	H54-4279-13	ITEM CARTON CASE	M2
-		*	H54-4282-13	ITEM CARTON CASE	K1
-		*	H54-4283-03	ITEM CARTON CASE	E3
-		*	H54-4284-03	ITEM CARTON CASE	E4
-		*	H54-4379-03	ITEM CARTON CASE	E5
-		*	H54-4380-03	ITEM CARTON CASE	K2
218	1F		H30-0595-04	ADHESIVE DOUBLE-COATED TAPE	KR1M1
218	1F		H30-0595-04	ADHESIVE DOUBLE-COATED TAPE	K2
218	1F		H30-0595-04	ADHESIVE DOUBLE-COATED TAPE	M2X1K1
220	2D		J11-0660-05	CLAMPER	E4
220	2D		J11-0660-05	CLAMPER	K1K2E3
221	1E		J21-9867-04	MOUNTING HARDWARE	E4
221	1E		J21-9867-04	MOUNTING HARDWARE	K1K2E3
222	1E		J22-0657-03	MOUNTING HARDWARE ASSY	
224	1E		N99-1779-15	SCREW SET	KR1M1
224	1E		N99-1779-15	SCREW SET	K2
224	1E		N99-1779-15	SCREW SET	M2X1K1
A	2D	*	N09-6731-05	MACHINE SCREW (BAINDO M3X14)	
B	3D		N35-2604-43	BINDING HEAD MACHINE SCREW	
C	2C	*	N35-2620-48	BINDING HEAD MACHINE SCREW	
D	3F		N78-2660-48	PAN HEAD TAPTITE SCREW	
E	1D		N86-2605-48	BINDING HEAD TAPTITE SCREW	
225	1E	*	W02-5305-05	ANTENNA MODULE	E4
225	1E	*	W02-5305-05	ANTENNA MODULE	K1K2E3
226	1F	*	W01-1718-05	MICROPHONE	E3
DISPLAY ASSY					
PA1	3E	*	A64-4530-11	PANEL ASSY	K
PA1	3E	*	A64-4532-11	PANEL ASSY	E1E2
PA1	3E	*	A64-4535-11	PANEL ASSY	K1
PA1	3E	*	A64-4536-11	PANEL ASSY	E3
PA1	3E	*	A64-4537-11	PANEL ASSY	E4
PA1	3E	*	A64-4539-01	PANEL ASSY	R1M1M2
PA1	3E	*	A64-4539-01	PANEL ASSY	X1
PA1	3E	*	A64-4540-01	PANEL ASSY	E5
PA1	3E	*	A64-4551-01	PANEL ASSY	K2
230	3E	*	B19-2492-13	LIGHTING BOARD	
232	3E		B43-1518-04	BADGE	
LCD1	3F	*	B38-1202-05	LCD	
FC4	2E	*	E39-0998-15	FLAT CABLE	
241	3E	*	K28-0302-04	KEY TOP (VOL)	
242	3E	*	K28-0304-03	KNOB ASSY (VOL)	
F	2F		N35-2003-48	BINDING HEAD MACHINE SCREW	
G	2F		N80-2008-43	PAN HEAD TAPTITE SCREW	
243	3E	*	S79-0862-05	SWITCH ASSY	

PARTS LIST

Ref. No.	Add	New	Parts No.	Description	Destination	Ref. No.	Add	New	Parts No.	Description	Destination
DVD PLAYER ASSY											
B	3D		N35-2604-43	BINDING HEAD MACHINE SCREW		C190			CE32AV0J221M	CHIP EL 220UF 6.3WV	
VME1	1C	*	X92-6160-00	DVD MECHANISM ASSY (DVS-8020V)		C191			CK73GB1H103K	CHIP C 0.010UF K	
CONTROL ASSY (NAVI MODULE ASSY)											
WH2	2D	*	E39-0993-25	WIRING HARNESS	E4	C192,193			CK73GB1H104K	CHIP C 0.10UF K	
WH2	2D	*	E39-0993-25	WIRING HARNESS	K1K2E3	C194			CK73GB1H103K	CHIP C 0.010UF K	
250	2D	*	W02-5306-05	NAVIGATION MODULE	K1K2	C195			CE32AV0J221M	CHIP EL 220UF 6.3WV	
250	2D	*	W02-5308-05	NAVIGATION MODULE	E3E4						
VIDEO CONTROL UNIT (X15-108x-xx)											
C1			C90-5670-05	ELECTRO 2200UF 16WV		C196			CE32AV0G331M	CHIP EL 330UF 4.0WV	
C4,5			CK73GB1H104K	CHIP C 0.10UF K		C197			CK73GB1H103K	CHIP C 0.010UF K	
C8			CK73GB1H104K	CHIP C 0.10UF K		C198,199			CK73GB1H104K	CHIP C 0.10UF K	
C9			CK73FB1A225K	CHIP C 2.2UF K		C200			CK73GB1H103K	CHIP C 0.010UF K	
C10			CE32BF1E101M	CHIP EL 100UF 25WV		C201			CK73GB1H102K	CHIP C 1000PF K	
C100,101			CC73GCH1H101J	CHIP C 100PF J		C204,205			CK73GB1A474K	CHIP C 0.47UF K	
C102			CK73GB1H104K	CHIP C 0.10UF K		C206			CE32BJ1C470M	CHIP EL 47UF 16WV	
C103			CC73GCH1H221J	CHIP C 220PF J		C207			CK73GB1A474K	CHIP C 0.47UF K	
C104,105			CC73GCH1H470J	CHIP C 47PF J		C208			CK73GB1H103K	CHIP C 0.010UF K	
C106,107			CK73GB1C473K	CHIP C 0.047UF K		C209			CK73GB1A474K	CHIP C 0.47UF K	
C108			CC73GCH1H221J	CHIP C 220PF J		C210			CK73GB0J475K	CHIP C 4.7UF K	
C109,110			CC73GCH1H470J	CHIP C 47PF J		C211			CK73FB0J106K	CHIP C 10UF K	
C111			CK73GB1C473K	CHIP C 0.047UF K		C212			CK73GB0J475K	CHIP C 4.7UF K	
C112,113			CC73GCH1H221J	CHIP C 220PF J		C213			CK73GB1H102K	CHIP C 1000PF K	
C116			CK73GB1H103K	CHIP C 0.010UF K		C214			CE32AV1A121M	CHIP EL 120UF 10WV	
C117			CK73GB1H223K	CHIP C 0.022UF K		C215-217			CK73GB1H102K	CHIP C 1000PF K	
C118,119			CK73GB1H103K	CHIP C 0.010UF K		C218			CK73GB1A105K	CHIP C 1.0UF K	
C120			CK73GB1H153K	CHIP C 0.015UF K		C219			CK73FB0J106K	CHIP C 10UF K	
C121			CK73GB1H223K	CHIP C 0.022UF K		C220			CE32BJ1C470M	CHIP EL 47UF 16WV	
C124-129			CK73GB1H102K	CHIP C 1000PF K		C222			CK73GB1H103K	CHIP C 0.010UF K	E1E2E5
C130,131			CK73FB0J106K	CHIP C 10UF K		C225-227			CK73GB1A105K	CHIP C 1.0UF K	
C132,133			CK73GB1H104K	CHIP C 0.10UF K		C229			CK73GB1H103K	CHIP C 0.010UF K	
C134,135			CK73FB0J106K	CHIP C 10UF K		C232			CK73GB1H104K	CHIP C 0.10UF K	
C136-141			CK73GB1H104K	CHIP C 0.10UF K		C233,234			CK73GB1A105K	CHIP C 1.0UF K	
C142,143			CK73EB1E225K	CHIP C 2.2UF K		C235,236			CE32BJ1C220M	CHIP EL 22UF 16WV	
C144-149			CK73GB1H104K	CHIP C 0.10UF K		C239			CK73GB1H103K	CHIP C 0.010UF K	
C150-157			CK73GB1H103K	CHIP C 0.010UF K		C240-243			CK73GB1A105K	CHIP C 1.0UF K	
C158-161			CK73GB1H104K	CHIP C 0.10UF K		C244			CK73FB0J106K	CHIP C 10UF K	
C162-169			CK73GB1H102K	CHIP C 1000PF K		C245			CK73GB1H104K	CHIP C 0.10UF K	
C170			C93-1367-05	CHIP C 10UF K		C246			CK73FB0J106K	CHIP C 10UF K	
C171			CK73GB1H103K	CHIP C 0.010UF K		C247			CK73GB1H104K	CHIP C 0.10UF K	
C172			CK73GB1H104K	CHIP C 0.10UF K		C248			CE32BQ0J331M	CHIP EL 330UF 6.3WV	
C173,174		*	CE32BQ1E680M	CHIP EL 68UF 25WV		C249			CK73GB1A105K	CHIP C 1.0UF K	
C175			CK73GB1H104K	CHIP C 0.10UF K		C250			CK73FB0J106K	CHIP C 10UF K	
C176			CK73GB1H103K	CHIP C 0.010UF K		C251-253			CK73GB1H103K	CHIP C 0.010UF K	
C177,178			C93-1367-05	CHIP C 10UF K		C254			CK73FB0J106K	CHIP C 10UF K	
C179			CK73GB1H103K	CHIP C 0.010UF K		C255-257			CK73GB1A474K	CHIP C 0.47UF K	
C180			CK73GB1H104K	CHIP C 0.10UF K		C265			CK73GB1H102K	CHIP C 1000PF K	
C181,182		*	CE32BQ1E680M	CHIP EL 68UF 25WV		C300,301			CK73GB1H104K	CHIP C 0.10UF K	E4K2
C183			CK73GB1H104K	CHIP C 0.10UF K		C300,301			CK73GB1H104K	CHIP C 0.10UF K	E5R1K1
C184			CK73GB1H103K	CHIP C 0.010UF K		C300,301			CK73GB1H104K	CHIP C 0.10UF K	KM1M2
C185			C93-1367-05	CHIP C 10UF K		C300,301			CK73GB1H104K	CHIP C 0.10UF K	X1E1E2
C186-189			CK73GB1H102K	CHIP C 1000PF K		C301			CK73GB1H104K	CHIP C 0.10UF K	E3
						C302			CK73GB1H103K	CHIP C 0.010UF K	
						C303			CK73GB1H104K	CHIP C 0.10UF K	
						C304			CK73GB1H103K	CHIP C 0.010UF K	
						C307			CK73GB1H104K	CHIP C 0.10UF K	
						C308			CK73GB1H103K	CHIP C 0.010UF K	
						C309			CE32BF1E101M	CHIP EL 100UF 25WV	
						C312,313			CK73GB1H102K	CHIP C 1000PF K	

E1: DDX5022 E2: DDX5022Y E3: DNX5220BT E4: DNX5220 E5: DDX52RY (Europe) △ Indicates safety critical components.
 K: DDX512 K1: DNX5120 K2: DNX512EX (North America)
 X1: DDX5032 (Australia) R1: DDX5032 (Latin America)
 M1: DDX5032 M2: DDX5032M (Other Areas)

PARTS LIST

VIDEO CONTROL UNIT (X15-108x-xx)

Ref. No.	Add	New	Parts No.	Description	Destination	Ref. No.	Add	New	Parts No.	Description	Destination
C314			CK73GB1H103K	CHIP C 0.010UF K		C826			CK73GB1A105K	CHIP C 1.0UF K	
C408			CK73GB1A474K	CHIP C 0.47UF K		C827,828			CK73GB1H104K	CHIP C 0.10UF K	
C410			CE32BJ0J470M	CHIP EL 47UF 6.3WV		C829			CK73GB1A105K	CHIP C 1.0UF K	
C412			CK73GB1A474K	CHIP C 0.47UF K		C830			CK73GB1H104K	CHIP C 0.10UF K	
C413			CE32BF1C221M	CHIP EL 220UF 16WV	E4	C833			CK73GB1A105K	CHIP C 1.0UF K	
C413			CE32BF1C221M	CHIP EL 220UF 16WV	K1K2E3	C834,835			CC73GCH1H100D	CHIP C 10PF D	
C414			CK73GB1H103K	CHIP C 0.010UF K	E4	C836-839			CK73FB0J106K	CHIP C 10UF K	
C414			CK73GB1H103K	CHIP C 0.010UF K	K1K2E3	C840			CK73GB1H104K	CHIP C 0.10UF K	
C501			CK73GB1H104K	CHIP C 0.10UF K	E3	C841			CE32BF1C221M	CHIP EL 220UF 16WV	
C502,503			CC73GCH1H100D	CHIP C 10PF D	E3	C842			CK73GB1H104K	CHIP C 0.10UF K	
C504-507			CK73GB1A105K	CHIP C 1.0UF K	E3	C843			CK73FB0J106K	CHIP C 10UF K	
C508			CK73FB0J106K	CHIP C 10UF K	E3	C851			CK73FB0J106K	CHIP C 10UF K	
C509			CC73GCH1H101J	CHIP C 100PF J	E3	C852			CK73GB1H104K	CHIP C 0.10UF K	
C510,511			CK73GB1H104K	CHIP C 0.10UF K	E3	C853,854			CC73GCH1H050C	CHIP C 5.0PF C	
C601-603			CK73GB1H104K	CHIP C 0.10UF K		C855			CK73GB1H104K	CHIP C 0.10UF K	
C604-606			CK73GB1A105K	CHIP C 1.0UF K		C864			CK73GB1H104K	CHIP C 0.10UF K	
C607			CK73FB0J106K	CHIP C 10UF K		C865			CK73GB1H102K	CHIP C 1000PF K	
C621-624			CK73GB1H104K	CHIP C 0.10UF K		CN1	*	E41-2685-05	PIN ASSY		
C625			CK73GB0J475K	CHIP C 4.7UF K		CN2		E41-2735-05	PIN ASSY		
C626-630			CK73GB1H104K	CHIP C 0.10UF K		CN301		E41-2237-05	FLAT CABLE CONNECTOR		
C631			CK73GB0J475K	CHIP C 4.7UF K		CN401		E41-2772-05	PIN ASSY	E4	
C632-638			CK73GB1H104K	CHIP C 0.10UF K		CN401		E41-2772-05	PIN ASSY	K1K2E3	
C651			CK73GB1A105K	CHIP C 1.0UF K		CN701		E41-2153-05	FLAT CABLE CONNECTOR		
C652			CK73GB1H104K	CHIP C 0.10UF K		J201		E11-0625-05	PHONE JACK (IPOD-A)		
C653			CK73FB0J106K	CHIP C 10UF K		J202	*	E11-0656-05	PHONE JACK (IPOD-V YELLOW)		
C654			CK73GB1H104K	CHIP C 0.10UF K		J203	*	E63-0956-05	RCA PIN JACK (AV-OUT,V-IN)		
C655,656			CK73FB0J106K	CHIP C 10UF K		J301		E58-1095-05	RECTANGULAR RECEPTACLE		
C657,658			CK73GB1H104K	CHIP C 0.10UF K		J401		E56-0864-05	CYLINDRICAL RECEPTACLE	E5R1	
C661,662			CK73EB1A106K	CHIP C 10UF K		J401		E56-0864-05	CYLINDRICAL RECEPTACLE	KM1M2	
C663,664			CK73GB1H222K	CHIP C 2200PF K		J401		E56-0864-05	CYLINDRICAL RECEPTACLE	X1E1E2	
C665,666			CK73GB1H271K	CHIP C 270PF K		J501		E11-0625-05	PHONE JACK	E3	
C667-670			CK73EB1A106K	CHIP C 10UF K		J502		E04-0324-05	RF COAXIAL CABLE RECEPTACLE	E3	
C672			CK73FB0J106K	CHIP C 10UF K		J681		E11-0625-05	PHONE JACK (DIGITAL-OUT)		
C673			CK73GB1H103K	CHIP C 0.010UF K		W801	*	E30-6777-05	CORD WITH CONNECTOR (USB CABLE)		
C691-693			CK73GB1H104K	CHIP C 0.10UF K		Δ L1		L33-2358-05	CHOKE COIL		
C701,702			CK73FB0J106K	CHIP C 10UF K		L100-103		L33-2369-05	CHOKE COIL (10U)		
C703	*		CE32BQ1E680M	CHIP EL 68UF 25WV		L104-107		L33-2370-05	CHOKE COIL (10U)		
C704			CK73GB1A105K	CHIP C 1.0UF K		L108		L92-0373-05	CHIP FERRITE		
C705-725			CK73GB1H104K	CHIP C 0.10UF K		L201		L92-0319-05	CHIP FERRITE		
C726,727			CC73GCH1H100D	CHIP C 10PF D		L202		L41-1005-33	SMALL FIXED INDUCTOR (10U)		
C728			CK73GB1H104K	CHIP C 0.10UF K		L203		L92-0319-05	CHIP FERRITE		
C729,730			CC73GCH1H220J	CHIP C 22PF J		L204		L41-1005-33	SMALL FIXED INDUCTOR (10U)		
C731			CK73FB0J106K	CHIP C 10UF K		L300		L92-0373-05	CHIP FERRITE	E4K2	
C732			CK73GB1H104K	CHIP C 0.10UF K		L300		L92-0373-05	CHIP FERRITE	E5R1K1	
C741			CK73GB0J475K	CHIP C 4.7UF K		L300		L92-0373-05	CHIP FERRITE		
C742-748			CK73GB1H104K	CHIP C 0.10UF K		L300		L92-0373-05	CHIP FERRITE	KM1M2	
C751			CK73GB0J475K	CHIP C 4.7UF K		L302		L92-0373-05	CHIP FERRITE	X1E1E2	
C752-758			CK73GB1H104K	CHIP C 0.10UF K		L302		L33-2369-05	CHOKE COIL		
C761,762			CK73FB0J106K	CHIP C 10UF K		L303		L92-0329-05	CHIP FERRITE		
C763,764			CK73GB1H104K	CHIP C 0.10UF K		L401		L33-2369-05	CHOKE COIL	E4	
C801-804			CK73GB1A105K	CHIP C 1.0UF K		L401		L33-2369-05	CHOKE COIL	K1K2E3	
C807			CK73GB1A105K	CHIP C 1.0UF K		L501,502		L92-0373-05	CHIP FERRITE	E3	
C808,809			CK73GB1H104K	CHIP C 0.10UF K		L601,602		L92-0319-05	CHIP FERRITE		
C811			CK73GB1A105K	CHIP C 1.0UF K		L651		L41-1005-33	SMALL FIXED INDUCTOR (10U)		
C812-825			CK73GB1H104K	CHIP C 0.10UF K		L701-706		L92-0373-05	CHIP FERRITE		

E1: DDX5022 E2: DDX5022Y E3: DNX5220BT E4: DNX5220 E5: DDX52RY (Europe) ΔIndicates safety critical components.

K: DDX512 K1: DNX5120 K2: DNX512EX (North America)

X1: DDX5032 (Australia) R1: DDX5032 (Latin America)

M1: DDX5032 M2: DDX5032M (Other Areas)

PARTS LIST

VIDEO CONTROL UNIT (X15-108x-xx)

Ref. No.	Add	New	Parts No.	Description	Destination	Ref. No.	Add	New	Parts No.	Description	Destination
L731			L92-0373-05	CHIP FERRITE		R203			RK73EB2E100J	CHIP R 10 J 1/4W	
L741			L92-0373-05	CHIP FERRITE		R204			RK73HB1J223J	CHIP R 22K J 1/16W	
L751			L92-0373-05	CHIP FERRITE		R205,206			RK73EB2E100J	CHIP R 10 J 1/4W	
L801			L92-0642-05	CHIP FERRITE		R207			RK73HB1J223J	CHIP R 22K J 1/16W	
L803			L92-0642-05	CHIP FERRITE		R208			RK73EB2E100J	CHIP R 10 J 1/4W	
L804,805			L92-0641-05	FERRITE CORE		R209			RK73GB2A222J	CHIP R 2.2K J 1/10W	
L806		*	L92-0651-05	CHIP FERRITE	E5R1	R210			RK73FB2B101J	CHIP R 100 J 1/8W	
L806		*	L92-0651-05	CHIP FERRITE	KM1M2	R211			RK73GB2A750J	CHIP R 75 J 1/10W	
L806		*	L92-0651-05	CHIP FERRITE	X1E1E2	R212			RK73EB2E101J	CHIP R 100 J 1/4W	
L806,807		*	L92-0651-05	CHIP FERRITE	E4	R213			RK73GB2A102J	CHIP R 1.0K J 1/10W	
L806,807		*	L92-0651-05	CHIP FERRITE	K1K2E3	R215			RK73HB1J100J	CHIP R 10 J 1/16W	
L808			L92-0641-05	FERRITE CORE	E4	R216,217			RK73HB1J000J	CHIP R 0.0 J 1/16W	
L808			L92-0641-05	FERRITE CORE	K1K2E3	R219			RK73GB2A000J	CHIP R 0.0 J 1/10W	
L811			L92-0373-05	CHIP FERRITE		R228			RK73GH2A471D	CHIP R 470 D 1/10W	
L851			L92-0319-05	CHIP FERRITE		R229			RK73HB1J332J	CHIP R 3.3K J 1/16W	
X701			L77-2866-05	CRYSTAL RESONATOR (27MHZ)		R235			RK73HB1J000J	CHIP R 0.0 J 1/16W	
X801			L77-2943-05	CRYSTAL RESONATOR (24.000MHZ)		R236-238			RK73GH2A102D	CHIP R 1.0K D 1/10W	
X851			L77-2921-05	CRYSTAL RESONATOR (32.768KHZ)		R239			RK73HB1J103J	CHIP R 10K J 1/16W	
F	1D		N35-2003-48	BINDING HEAD MACHINE SCREW	E3	R240			RK73HB1J000J	CHIP R 0.0 J 1/16W	
H	1D		N82-2608-48	BINDING HEAD TAPTITE SCREW		R241			RK73GH2A102D	CHIP R 1.0K D 1/10W	
CP701-715			RK74HB1J220J	CHIP-COM 22 J 1/16W		R243			RK73HB1J101J	CHIP R 100 J 1/16W	
CP721-724			RK74HB1J330J	CHIP-COM 33 J 1/16W		R244			RK73HB1J103J	CHIP R 10K J 1/16W	
CP751,752			RK74HB1J103J	CHIP-COM 10K J 1/16W		R245			RK73GH2A102D	CHIP R 1.0K D 1/10W	
CP753,754			RK74HB1J220J	CHIP-COM 22 J 1/16W		R246-249			RK73HB1J105J	CHIP R 1.0M J 1/16W	
R6			RK73GB2A823J	CHIP R 82K J 1/10W		R250			RK73HB1J103J	CHIP R 10K J 1/16W	
R7			RK73GB2A103J	CHIP R 10K J 1/10W		R251,252			RK73HB1J000J	CHIP R 0.0 J 1/16W	
R8			RK73GB2A224J	CHIP R 220K J 1/10W		R253			RK73HB1J332J	CHIP R 3.3K J 1/16W	
R9			RK73GB2A333J	CHIP R 33K J 1/10W		R254			RK73GH2A102D	CHIP R 1.0K D 1/10W	
R10			RK73GB2A224J	CHIP R 220K J 1/10W		R255,256			RK73HB1J105J	CHIP R 1.0M J 1/16W	
R100			RK73GB2A000J	CHIP R 0.0 J 1/10W		R257,258			RK73HB1J101J	CHIP R 100 J 1/16W	
R101			RK73GH2A681D	CHIP R 680 D 1/10W		R259			RK73HB1J103J	CHIP R 10K J 1/16W	
R102			RK73GH2A221D	CHIP R 220 D 1/10W		R260,261			RK73HB1J101J	CHIP R 100 J 1/16W	
R103			RK73GH2A681D	CHIP R 680 D 1/10W		R263			RK73HB1J101J	CHIP R 100 J 1/16W	
R104			RK73GH2A561D	CHIP R 560 D 1/10W		R265			RK73GH2A102D	CHIP R 1.0K D 1/10W	
R105-108			RK73GB2A683J	CHIP R 68K J 1/10W		R266			RK73EB2E750J	CHIP R 75 J 1/4W	
R109			RK73GB2A103J	CHIP R 10K J 1/10W		R267-269			RK73HB1J272J	CHIP R 2.7K J 1/16W	
R110			RK73GH2A562D	CHIP R 5.6K D 1/10W		R270			RK73GB2A750J	CHIP R 75 J 1/10W	
R111			RK73GB2A103J	CHIP R 10K J 1/10W		R271			RK73EB2E101J	CHIP R 100 J 1/4W	
R112			RK73GH2A472D	CHIP R 4.7K D 1/10W		R272			RK73HB1J100J	CHIP R 10 J 1/16W	
R113			RK73GH2A562D	CHIP R 5.6K D 1/10W		R273-276			RK73HB1J473J	CHIP R 47K J 1/16W	
R114			RK73GH2A103D	CHIP R 10K D 1/10W		R277			RK73GB2A000J	CHIP R 0.0 J 1/10W	
R119-122			RK73GH2A333D	CHIP R 33K D 1/10W		R279			RK73GB2A000J	CHIP R 0.0 J 1/10W	
R123-134			RK73GB2A000J	CHIP R 0.0 J 1/10W		R282			RK73HB1J000J	CHIP R 0.0 J 1/16W	
R135,136			RK73GB2A220J	CHIP R 22 J 1/10W		R283			RK73HB1J103J	CHIP R 10K J 1/16W	E4
R137,138			RK73GB2A000J	CHIP R 0.0 J 1/10W		R283			RK73HB1J103J	CHIP R 10K J 1/16W	K1K2E3
R139			RK73GB2A220J	CHIP R 22 J 1/10W		R284			RK73HB1J000J	CHIP R 0.0 J 1/16W	E5R1
R140,141			RK73GB2A000J	CHIP R 0.0 J 1/10W		R284			RK73HB1J000J	CHIP R 0.0 J 1/16W	KM1M2
R142			RK73GB2A220J	CHIP R 22 J 1/10W		R284			RK73HB1J000J	CHIP R 0.0 J 1/16W	X1E1E2
R143-152			RK73EB2E100J	CHIP R 10 J 1/4W		R284-289			RK73HB1J102J	CHIP R 1.0K J 1/16W	E4
R153-156			R92-5158-05	CHIP R 0.022 J 1/4W		R284-289			RK73HB1J102J	CHIP R 1.0K J 1/16W	K1K2E3
R158			R92-5159-05	CHIP R 0.033 J 1/4W		R286			RK73HB1J000J	CHIP R 0.0 J 1/16W	E5R1
R159			R92-5158-05	CHIP R 0.022 J 1/4W		R286			RK73HB1J000J	CHIP R 0.0 J 1/16W	KM1M2
R161-167			RK73GB2A000J	CHIP R 0.0 J 1/10W		R286			RK73HB1J000J	CHIP R 0.0 J 1/16W	X1E1E2
R201,202			RK73HB1J202J	CHIP R 2.0K J 1/16W		R288			RK73HB1J000J	CHIP R 0.0 J 1/16W	E5R1
						R288			RK73HB1J000J	CHIP R 0.0 J 1/16W	KM1M2

E1: DDX5022 E2: DDX5022Y E3: DNX5220BT E4: DNX5220 E5: DDX52RY (Europe) △ Indicates safety critical components.
 K: DDX512 K1: DNX5120 K2: DNX512EX (North America)
 X1: DDX5032 (Australia) R1: DDX5032 (Latin America)
 M1: DDX5032 M2: DDX5032M (Other Areas)

PARTS LIST

VIDEO CONTROL UNIT (X15-108x-xx)

Ref. No.	Add	New	Parts No.	Description	Destination	Ref. No.	Add	New	Parts No.	Description	Destination
R288			RK73HB1J000J	CHIP R 0.0 J 1/16W	X1E1E2	R512,513			RK73EB2E101J	CHIP R 100 J 1/4W	E3
R290			RK73HB1J000J	CHIP R 0.0 J 1/16W		R601			RK73GB2A000J	CHIP R 0.0 J 1/10W	
R302			RK73GB2A000J	CHIP R 0.0 J 1/10W		R603			RK73GH2A471D	CHIP R 470 D 1/10W	
R304,305			RK73HB1J101J	CHIP R 100 J 1/16W	E4K2	R604-606			RK73GH2A102D	CHIP R 1.0K D 1/10W	
R304,305			RK73HB1J101J	CHIP R 100 J 1/16W	E5R1K1	R613			RK73GH2A331D	CHIP R 330 D 1/10W	
R304,305			RK73HB1J101J	CHIP R 100 J 1/16W	KM1M2	R614	*		RK73GH2A150D	CHIP R 15 D 1/10W	
R304,305			RK73HB1J101J	CHIP R 100 J 1/16W	X1E1E2	R615-617			RK73HB1J000J	CHIP R 0.0 J 1/16W	
R309			RK73FB2B000J	CHIP R 0.0 J 1/8W		R620-625			RK73GH2A750D	CHIP R 75 D 1/10W	
R310			RK73HB1J472J	CHIP R 4.7K J 1/16W	E4K2	R626	*		RK73GH2A240D	CHIP R 24 D 1/10W	
R310			RK73HB1J472J	CHIP R 4.7K J 1/16W	E5R1K1	R627			RK73GH2A151D	CHIP R 150 D 1/10W	
R310			RK73HB1J472J	CHIP R 4.7K J 1/16W	KM1M2	R628			RK73HB1J000J	CHIP R 0.0 J 1/16W	
R310			RK73HB1J472J	CHIP R 4.7K J 1/16W	X1E1E2	R629			RK73GH2A750D	CHIP R 75 D 1/10W	
R311-314			RK73HB1J103J	CHIP R 10K J 1/16W	E4K2	R651-654			RK73HB1J220J	CHIP R 22 J 1/16W	
R311-314			RK73HB1J103J	CHIP R 10K J 1/16W	E5R1K1	R655-657			RK73HB1J000J	CHIP R 0.0 J 1/16W	
R311-314			RK73HB1J103J	CHIP R 10K J 1/16W	KM1M2	R658-660			RK73GB2A2R2J	CHIP R 2.2 J 1/10W	
R311-314			RK73HB1J103J	CHIP R 10K J 1/16W	X1E1E2	R661,662			RK73HB1J103J	CHIP R 10K J 1/16W	
R403-405			RK73EB2E102J	CHIP R 1.0K J 1/4W		R663,664			RK73HB1J102J	CHIP R 1.0K J 1/16W	
R406			RK73HB1J101J	CHIP R 100 J 1/16W		R665,666			RK73HB1J752J	CHIP R 7.5K J 1/16W	
R407			RK73GB2A000J	CHIP R 0.0 J 1/10W	E4	R667,668			RK73HB1J471J	CHIP R 470 J 1/16W	
R407			RK73GB2A000J	CHIP R 0.0 J 1/10W	K1K2E3	R669-672			RK73HB1J473J	CHIP R 47K J 1/16W	
R412-415			RK73GB2A750J	CHIP R 75 J 1/10W	E5R1	R673,674			RK73HB1J103J	CHIP R 10K J 1/16W	
R412-415			RK73GB2A750J	CHIP R 75 J 1/10W	KM1M2	R681			RK73HB1J103J	CHIP R 10K J 1/16W	
R412-415			RK73GB2A750J	CHIP R 75 J 1/10W	X1E1E2	R683-686			RK73HB1J220J	CHIP R 22 J 1/16W	
R416			RK73EB2E101J	CHIP R 100 J 1/4W	E5R1	R687			RK73HB1J103J	CHIP R 10K J 1/16W	
R416			RK73EB2E101J	CHIP R 100 J 1/4W	KM1M2	R688			RK73HB1J220J	CHIP R 22 J 1/16W	
R416			RK73EB2E101J	CHIP R 100 J 1/4W	X1E1E2	R690			RK73HB1J220J	CHIP R 22 J 1/16W	
R417			RK73HB1J100J	CHIP R 10 J 1/16W	E5R1	R691			RK73HB1J100J	CHIP R 10 J 1/16W	
R417			RK73HB1J100J	CHIP R 10 J 1/16W	KM1M2	R692			RK73GB2A151J	CHIP R 150 J 1/10W	
R417			RK73HB1J100J	CHIP R 10 J 1/16W	X1E1E2	R693			RK73EB2E750J	CHIP R 75 J 1/4W	
R418			RK73EB2E101J	CHIP R 100 J 1/4W	E5R1	R694,695			RK73GB2A000J	CHIP R 0.0 J 1/10W	
R418			RK73EB2E101J	CHIP R 100 J 1/4W	KM1M2	R696			RK73HB1J220J	CHIP R 22 J 1/16W	
R418			RK73EB2E101J	CHIP R 100 J 1/4W	X1E1E2	R697,698			RK73HB1J151J	CHIP R 150 J 1/16W	
R419			RK73HB1J100J	CHIP R 10 J 1/16W	E5R1	R699			RK73HB1J000J	CHIP R 0.0 J 1/16W	
R419			RK73HB1J100J	CHIP R 10 J 1/16W	KM1M2	R702			RK73GB2A000J	CHIP R 0.0 J 1/10W	
R419			RK73HB1J100J	CHIP R 10 J 1/16W	X1E1E2	R703			RK73HB1J102J	CHIP R 1.0K J 1/16W	
R420			RK73EB2E101J	CHIP R 100 J 1/4W	E5R1	R704			RK73HB1J101J	CHIP R 100 J 1/16W	
R420			RK73EB2E101J	CHIP R 100 J 1/4W	KM1M2	R706-708			RK73HB1J000J	CHIP R 0.0 J 1/16W	
R420			RK73EB2E101J	CHIP R 100 J 1/4W	X1E1E2	R709-713			RK73HB1J220J	CHIP R 22 J 1/16W	
R421			RK73HB1J100J	CHIP R 10 J 1/16W	E5R1	R715-730			RK73HB1J000J	CHIP R 0.0 J 1/16W	
R421			RK73HB1J100J	CHIP R 10 J 1/16W	KM1M2	R732-738			RK73HB1J220J	CHIP R 22 J 1/16W	
R421			RK73HB1J100J	CHIP R 10 J 1/16W	X1E1E2	R739,740			RK73HB1J101J	CHIP R 100 J 1/16W	
R422			RK73EB2E101J	CHIP R 100 J 1/4W	E5R1	R742-746			RK73HB1J101J	CHIP R 100 J 1/16W	
R422			RK73EB2E101J	CHIP R 100 J 1/4W	KM1M2	R748-753			RK73HB1J220J	CHIP R 22 J 1/16W	
R422			RK73EB2E101J	CHIP R 100 J 1/4W	X1E1E2	R754-756			RK73HB1J101J	CHIP R 100 J 1/16W	
R423			RK73HB1J100J	CHIP R 10 J 1/16W	E5R1	R758			RK73HB1J105J	CHIP R 1.0M J 1/16W	
R423			RK73HB1J100J	CHIP R 10 J 1/16W	KM1M2	R759			RK73GB2A102J	CHIP R 1.0K J 1/10W	
R423			RK73HB1J100J	CHIP R 10 J 1/16W	X1E1E2	R760-762			RK73HB1J000J	CHIP R 0.0 J 1/16W	
R424			RK73EB2E100J	CHIP R 10 J 1/4W		R763,764			RK73HB1J220J	CHIP R 22 J 1/16W	
R425			RK73EB2E4R7J	CHIP R 4.7 J 1/4W		R765			RK73HB1J000J	CHIP R 0.0 J 1/16W	
R428			RK73EB2E100J	CHIP R 10 J 1/4W		R767			RK73HB1J000J	CHIP R 0.0 J 1/16W	
R501,502			RK73HB1J104J	CHIP R 100K J 1/16W	E3	R769			RK73GH2A153D	CHIP R 15K D 1/10W	
R503,504			RK73HB1J223J	CHIP R 22K J 1/16W	E3	R770			RK73GH2A123D	CHIP R 12K D 1/10W	
R505,506			RK73HB1J104J	CHIP R 100K J 1/16W	E3	R771			RK73HB1J103J	CHIP R 10K J 1/16W	E5R1E3
R507,508			RK73HB1J223J	CHIP R 22K J 1/16W	E3	R771			RK73HB1J103J	CHIP R 10K J 1/16W	KM1M2
R509			RK73HB1J473J	CHIP R 47K J 1/16W	E3	R771			RK73HB1J103J	CHIP R 10K J 1/16W	X1E1E2

E1: DDX5022 E2: DDX5022Y E3: DNX5220BT E4: DNX5220 E5: DDX52RY (Europe) ΔIndicates safety critical components.

K: DDX512 K1: DNX5120 K2: DNX512EX (North America)

X1: DDX5032 (Australia) R1: DDX5032 (Latin America)

M1: DDX5032 M2: DDX5032M (Other Areas)

PARTS LIST

VIDEO CONTROL UNIT (X15-108x-xx)

Ref. No.	Add	New	Parts No.	Description	Destination	Ref. No.	Add	New	Parts No.	Description	Destination
R772,773			RK73HB1J103J	CHIP R 10K J 1/16W	K1E4K2	D100-103			1SS357-F	DIODE	
R773			RK73HB1J103J	CHIP R 10K J 1/16W	E5R1E3	D201			DAP202U	DIODE	
R773			RK73HB1J103J	CHIP R 10K J 1/16W	KM1M2	D202			UDZS4.7B	ZENER DIODE	
R773			RK73HB1J103J	CHIP R 10K J 1/16W	X1E1E2	D203			CVL10C270M300	VARIATOR	
R776			RK73HB1J103J	CHIP R 10K J 1/16W		D204-206			CVS10A120M	VARIATOR	
R777			RK73HB1J102J	CHIP R 1.0K J 1/16W		D207			CVL10C270M300	VARIATOR	
R780			RK73FB2B000J	CHIP R 0.0 J 1/8W		D212,213			CVL10C270M300	VARIATOR	
R781			RK73GB2A000J	CHIP R 0.0 J 1/10W		D301			1SS355	DIODE	E4K2
R805,806			RK73EB2E4R7J	CHIP R 4.7 J 1/4W		D301			1SS355	DIODE	E5R1K1
R808,809			RK73EB2E4R7J	CHIP R 4.7 J 1/4W	E4	D301			1SS355	DIODE	KM1M2
R808,809			RK73EB2E4R7J	CHIP R 4.7 J 1/4W	K1K2E3	D301			1SS355	DIODE	X1E1E2
R810,811			RK73GB2A000J	CHIP R 0.0 J 1/10W		D400-403			UDZS6.2B	ZENER DIODE	E5R1
R812			RK73HB1J103J	CHIP R 10K J 1/16W		D400-403			UDZS6.2B	ZENER DIODE	KM1M2
R814			RK73HB1J103J	CHIP R 10K J 1/16W		D400-403			UDZS6.2B	ZENER DIODE	X1E1E2
R815			RK73GH2A622D	CHIP R 6.2K D 1/10W		D404			STZ6.8N	ZENER DIODE	E5R1
R820			RK73HB1J000J	CHIP R 0.0 J 1/16W		D404			STZ6.8N	ZENER DIODE	KM1M2
R821			RK73GH2A622D	CHIP R 6.2K D 1/10W		D404			STZ6.8N	ZENER DIODE	X1E1E2
R823			RK73HB1J103J	CHIP R 10K J 1/16W		D405-408			CVL10C270M300	VARIATOR	E5R1
R825			RK73HB1J102J	CHIP R 1.0K J 1/16W		D405-408			CVL10C270M300	VARIATOR	KM1M2
R826			RK73HB1J103J	CHIP R 10K J 1/16W		D405-408			CVL10C270M300	VARIATOR	X1E1E2
R831			RK73GB2A000J	CHIP R 0.0 J 1/10W		D501			STZ6.8N	ZENER DIODE	E3
R832			RK73GB2A515J	CHIP R 5.1M J 1/10W		D651			DAP202U	DIODE	
R833-836			RK73HB1J103J	CHIP R 10K J 1/16W		D681			CVL10C270M300	VARIATOR	
R837			RK73HB1J000J	CHIP R 0.0 J 1/16W		D682			DA204U	DIODE	
R838			RK73HB1J220J	CHIP R 22 J 1/16W		D701			DAP202U	DIODE	
R840,841			RK73HB1J103J	CHIP R 10K J 1/16W		D801,802			AVRL1613R3FTA	VARIATOR	
R843			RK73HB1J000J	CHIP R 0.0 J 1/16W		IC100,101			LTC3728LEGN	ANALOGUE IC	
R844			RK73HB1J103J	CHIP R 10K J 1/16W		IC201			NJM2794RB2ZB	ANALOGUE IC	
R845			RK73GH2A104D	CHIP R 100K D 1/10W		IC202			NJM2505AF-ZB	ANALOGUE IC	
R846			RK73HB1J102J	CHIP R 1.0K J 1/16W		IC203			XC6201P502PR	ANALOGUE IC	
R847			RK73HB1J103J	CHIP R 10K J 1/16W		IC205		*	AN15885A-VF	ANALOGUE IC	
R848			RK73HB1J331J	CHIP R 330 J 1/16W		IC206			MM1508XNRE-E	ANALOGUE IC	
R851			RK73HB1J473J	CHIP R 47K J 1/16W		IC207		*	NJM2286V-ZB	ANALOGUE IC	
R853-856			RK73HB1J103J	CHIP R 10K J 1/16W		IC301			74AHCT08PW	MOS-IC	E4K2
R857-860			RK73HB1J152J	CHIP R 1.5K J 1/16W		IC301			74AHCT08PW	MOS-IC	E5R1K1
R861			RK73HB1J472J	CHIP R 4.7K J 1/16W	E4K2	IC301			74AHCT08PW	MOS-IC	KM1M2
R861			RK73HB1J472J	CHIP R 4.7K J 1/16W	E5R1K1	IC301			74AHCT08PW	MOS-IC	X1E1E2
R861			RK73HB1J472J	CHIP R 4.7K J 1/16W	KM1M2	IC501			NJM4565V-ZB	ANALOGUE IC	E3
R861			RK73HB1J472J	CHIP R 4.7K J 1/16W	X1E1E2	IC502			TC7WH126FU-F	MOS-IC	E3
R861,862			RK73HB1J472J	CHIP R 4.7K J 1/16W	E3	IC601			MM1671XNRE	ANALOGUE IC	
R863-880			RK73HB1J103J	CHIP R 10K J 1/16W		IC602			NJM2573V-ZB	ANALOGUE IC	
R881			RK73HB1J202J	CHIP R 2.0K J 1/16W		IC651			PCM1754DB	MOS-IC	
R883			RK73HB1J103J	CHIP R 10K J 1/16W		IC652			NJM4565V-ZB	ANALOGUE IC	
R884,885			RK73HB1J000J	CHIP R 0.0 J 1/16W		IC653			XC6201P502PR	ANALOGUE IC	
R886			RK73HB1J473J	CHIP R 47K J 1/16W		IC654			NJM4565V-ZB	ANALOGUE IC	
R887			RK73HB1J103J	CHIP R 10K J 1/16W		IC691		*	74AHC1G04GW	MOS-IC	
R900			RK73HB1J220J	CHIP R 22 J 1/16W		IC692			74AHC1G08GW	MOS-IC	
R905,906			RK73HB1J220J	CHIP R 22 J 1/16W		IC701		*	MS8312A-CMG	MICROPROCESSOR IC	
R907			RK73HB1J103J	CHIP R 10K J 1/16W		IC702			S29GL64A914Z4	ROM IC	
R913,914			RK73HB1J105J	CHIP R 1.0M J 1/16W		IC703,704		*	A2V28S40CTPG6	DRAM IC	
R915			RK73HB1J000J	CHIP R 0.0 J 1/16W		IC705			SI-3010KD	ANALOGUE IC	
R919			RK73HB1J000J	CHIP R 0.0 J 1/16W		IC801		*	S1R72C05F15	MOS-IC	
L503	*		T90-0587-05	CHIP ANTENNA	E3	IC804		*	MIC2005-08YM6	MOS-IC	
						IC805			XC6219B332PR	ANALOGUE IC	
						IC806			XC6219B182PR	ANALOGUE IC	

PARTS LIST

VIDEO CONTROL UNIT (X15-108x-xx)

Ref. No.	Add	New	Parts No.	Description	Destination
IC851 IC853 Q1 Q2,3 Q4		*	341S2094 74AHC573PW DTC143ZUA 2SA1576A TPC8110-F	MICROPROCESSOR IC MOS-IC DIGITAL TRANSISTOR TRANSISTOR FET	
Q100-103 Q104-107 Q202-204 Q205-207 Q301,302			DTC124XUA HAT2218R-E 2SA1576A 2SC4081 2SC4081	DIGITAL TRANSISTOR DUAL FET TRANSISTOR TRANSISTOR TRANSISTOR	E4K2
Q301,302 Q301,302 Q301,302 Q303 Q303			2SC4081 2SC4081 2SC4081 UMG2N UMG2N	TRANSISTOR TRANSISTOR TRANSISTOR TRANSISTOR TRANSISTOR	E5R1K1 KM1M2 X1E1E2 E4K2 E5R1K1
Q303 Q303 Q651,652 Q653 Q654			UMG2N UMG2N DTC643TU DTA114EUA DTC143ZUA	TRANSISTOR TRANSISTOR DIGITAL TRANSISTOR DIGITAL TRANSISTOR DIGITAL TRANSISTOR	KM1M2 X1E1E2
Q681			2SA1576A	TRANSISTOR	
A501		*	W02-5292-05	ELECTRIC CIRCUIT MODULE (BLUET)	E3
ELECTRIC UNIT (X34-575x-xx)					
C1 C2 C4 C6 C8			CK73FB1E474K CK73GB1H222K C90-6851-05 CK73GB1H222K CK73GB1H103K	CHIP C 0.47UF K CHIP C 2200PF K ELECTRO 220UF 25WV CHIP C 2200PF K CHIP C 0.010UF K	
C9,10 C14 C15 C16 C17			CK73GB1H222K CK73FB1A335K CK73GB1A105K CK73GB1H103K CK73GB1A105K	CHIP C 2200PF K CHIP C 3.3UF K CHIP C 1.0UF K CHIP C 0.010UF K CHIP C 1.0UF K	
C18,19 C20 C20 C21 C24,25			CK73GB1H222K CK73GB1H103K CK73GB1H103K CK73FB0J106K CK73GB1H222K	CHIP C 2200PF K CHIP C 0.010UF K CHIP C 0.010UF K CHIP C 10UF K CHIP C 2200PF K	E4 K1K2E3
C26 C29 C30 C31 C32			CK73GB1H104K CD04AS0J101M CK73FB1C105K CK73GB1A105K CK73GB1H103K	CHIP C 0.10UF K ELECTRO 100UF 6.3WV CHIP C 1.0UF K CHIP C 1.0UF K CHIP C 0.010UF K	
C33 C34 C35 C36 C36			CK73GB1A105K CD04AR1C221M CK73GB1A105K CC73GCH1H101J CC73GCH1H101J	CHIP C 1.0UF K ELECTRO 220UF 16WV CHIP C 1.0UF K CHIP C 100PF J CHIP C 100PF J	E1E2E5 E3E4
C37 C38 C38 C41 C43-45			CK73GB1H103K C93-1470-05 C93-1470-05 CK73GB1A105K CK73GB1H103K	CHIP C 0.010UF K CHIP C 15000PF F CHIP C 15000PF F CHIP C 1.0UF K CHIP C 0.010UF K	E1E2E5 E3E4

Ref. No.	Add	New	Parts No.	Description	Destination
C46 C47 C100 C101 C102			CK73FB1E474K C90-5612-05 CK73GB1H104K CK73GB1H103K CK73GB1H104K	CHIP C 0.47UF K ELECTRO 3900UF 16WV CHIP C 0.10UF K CHIP C 0.010UF K CHIP C 0.10UF K	
C104 C105,106 C105,106 C106 C106			CK73GB1H104K CK73GB1H103K CK73GB1H103K CK73GB1H103K CK73GB1H103K	CHIP C 0.10UF K CHIP C 0.010UF K CHIP C 0.010UF K CHIP C 0.010UF K CHIP C 0.010UF K	E4 K1K2E3 E5R1 KM1M2
C106 C108 C109 C110 C111			CK73GB1H103K CC73GCH1H220J CC73GCH1H180J CK73FB0J106K CK73GB1H473K	CHIP C 0.010UF K CHIP C 22PF J CHIP C 18PF J CHIP C 10UF K CHIP C 0.047UF K	X1E1E2
C112 C113 C114 C115,116 C117			CK73GB1H102K CK73GB1H103K CD04AS0J101M CK73GB1H103K CK73GB1H104K	CHIP C 1000PF K CHIP C 0.010UF K ELECTRO 100UF 6.3WV CHIP C 0.010UF K CHIP C 0.10UF K	
C119 C120 C121 C122,123 C124			CK73GB1H104K CK73GB1H102K CK73GB1H104K CK73GB1H103K CK73GB1H104K	CHIP C 0.10UF K CHIP C 1000PF K CHIP C 0.10UF K CHIP C 0.010UF K CHIP C 0.10UF K	
C125 C126-129 C132,133 C302 C303,304			CK73GB1H102K CK73GB1H104K CC73GCH1H070D CD04AS1C470M CK73GB1A474K	CHIP C 1000PF K CHIP C 0.10UF K CHIP C 7.0PF D ELECTRO 47UF 16WV CHIP C 0.47UF K	
C305,306 C307,308 C316 C318 C321			CE32BJ1H2R2M CK73GB1A474K CK73GB1A105K CE32BJ1C100M CK73GB1H103K	CHIP EL 2.2UF 50WV CHIP C 0.47UF K CHIP C 1.0UF K CHIP EL 10UF 16WV CHIP C 0.010UF K	
C322 C323,324 C325 C326 C327			CE32BJ1C100M CK73GB1H103K CK73FB1A335K CK73GB1A105K CK73FB1A335K	CHIP EL 10UF 16WV CHIP C 0.010UF K CHIP C 3.3UF K CHIP C 1.0UF K CHIP C 3.3UF K	
C328,329 C330-332 C334 C335 C336			CK73GB1A105K CE32BJ1H010M CK73FB1E474K CE32BJ0J470M CK73FB1E474K	CHIP C 1.0UF K CHIP EL 1.0UF 50WV CHIP C 0.47UF K CHIP EL 47UF 6.3WV CHIP C 0.47UF K	
C400 C400 C400 C401 C401			CD04AS1C220M CD04AS1C220M CD04AS1C220M CK73GB1H103K CK73GB1H103K	ELECTRO 22UF 16WV ELECTRO 22UF 16WV ELECTRO 22UF 16WV CHIP C 0.010UF K CHIP C 0.010UF K	E1E2M1 E3E4 M2X1E5 E1E2M1 E3E4
C401 C402-405 C402-405 C402-405 C417-420			CK73GB1H103K CK73GB1A474K CK73GB1A474K CK73GB1A474K CK73GB1A474K	CHIP C 0.010UF K CHIP C 0.47UF K CHIP C 0.47UF K CHIP C 0.47UF K CHIP C 0.47UF K	M2X1E5 E1E2M1 E3E4 M2X1E5 E4K2

PARTS LIST

ELECTRIC UNIT (X34-575x-xx)

Ref. No.	Add	New	Parts No.	Description	Destination	Ref. No.	Add	New	Parts No.	Description	Destination
C417-420			CK73GB1A474K	CHIP C 0.47UF K	E5R1K1	C620,621			C90-6780-05	ELECTRO 1UF 16WV	
C417-420			CK73GB1A474K	CHIP C 0.47UF K	KM1M2	C623,624			C90-6779-05	ELECTRO 0.47UF 16WV	
C417-420			CK73GB1A474K	CHIP C 0.47UF K	X1E1E2	C626			CK73GB1A105K	CHIP C 1.0UF K	
C424			CK73GB1H104K	CHIP C 0.10UF K	E4K2	C627			CC73GCH1H050C	CHIP C 5.0PF C	
C424			CK73GB1H104K	CHIP C 0.10UF K	E5R1K1	C700			CE32BJ1C100M	CHIP EL 10UF 16WV	
C424			CK73GB1H104K	CHIP C 0.10UF K	KM1M2	C701,702			CK73GB1H102K	CHIP C 1000PF K	
C424			CK73GB1H104K	CHIP C 0.10UF K	X1E1E2	C703,704			CE32BJ1C100M	CHIP EL 10UF 16WV	
C425			CD04AS1C220M	ELECTRO 22UF 16WV	E4K2	C705,706			CK73GB1H102K	CHIP C 1000PF K	
C425			CD04AS1C220M	ELECTRO 22UF 16WV	E5R1K1	C707			CE32BJ1C100M	CHIP EL 10UF 16WV	
C425			CD04AS1C220M	ELECTRO 22UF 16WV	KM1M2	C711			CE32BJ1C100M	CHIP EL 10UF 16WV	
C425			CD04AS1C220M	ELECTRO 22UF 16WV	X1E1E2	C712,713			CK73GB1H102K	CHIP C 1000PF K	
C426,427			CK73GB1H103K	CHIP C 0.010UF K	E4K2	C714			CE32BJ1C100M	CHIP EL 10UF 16WV	
C426,427			CK73GB1H103K	CHIP C 0.010UF K	E5R1K1	C715			CK73GB1H104K	CHIP C 0.10UF K	
C426,427			CK73GB1H103K	CHIP C 0.010UF K	KM1M2	C800,801			CK73GB1H103K	CHIP C 0.010UF K	
C426,427			CK73GB1H103K	CHIP C 0.010UF K	X1E1E2	C807,808			CK73GB1H222K	CHIP C 2200PF K	
C430			CK73GB1H103K	CHIP C 0.010UF K	E1E2M1	C809			CK73FB1C105K	CHIP C 1.0UF K	
C430			CK73GB1H103K	CHIP C 0.010UF K	E3E4	C810			CD04AS1C101M	ELECTRO 100UF 16WV	
C430			CK73GB1H103K	CHIP C 0.010UF K	M2X1E5	C811			CK73GB1H103K	CHIP C 0.010UF K	
C500			CK73GB1A105K	CHIP C 1.0UF K		CN1	*		E41-2685-05	PIN ASSY	
C501			CC73GCH1H100D	CHIP C 10PF D	E2M1M2	CN100	*		E41-2248-05	PIN ASSY	
C501			CC73GCH1H100D	CHIP C 10PF D	E3E4	CN800	*		E41-2979-05	FLAT CABLE CONNECTOR	
C501			CC73GCH1H100D	CHIP C 10PF D	E5K1K2	CN801	*		E41-2980-05	FLAT CABLE CONNECTOR	
C502			CD04AS1C101M	ELECTRO 100UF 16WV	KR1E1	J1			E58-1043-05	RECTANGULAR RECEPTACLE (POWER)	
C512-514			CK73GB1H103K	CHIP C 0.010UF K		J400			E58-1034-05	RECTANGULAR RECEPTACLE (TV-TU)	E1E2M1
C515			CK73GB1H102K	CHIP C 1000PF K	E3E4	J400			E58-1034-05	RECTANGULAR RECEPTACLE (TV-TU)	E3E4
C520			CC73GCH1H100D	CHIP C 10PF D	E2M1M2	J400			E58-1034-05	RECTANGULAR RECEPTACLE (TV-TU)	M2X1E5
C520			CC73GCH1H100D	CHIP C 10PF D	E3E4	J401	*		E58-1097-05	RECTANGULAR RECEPTACLE (EXT-IF)	E4K2
C520			CC73GCH1H100D	CHIP C 10PF D	E5K1K2	J401	*		E58-1097-05	RECTANGULAR RECEPTACLE (EXT-IF)	E5R1K1
C520			CC73GCH1H100D	CHIP C 10PF D	KR1E1	J401	*		E58-1097-05	RECTANGULAR RECEPTACLE (EXT-IF)	KM1M2
C521			CK73GB1H103K	CHIP C 0.010UF K	E2M1M2	J401	*		E58-1097-05	RECTANGULAR RECEPTACLE (EXT-IF)	X1E1E2
C521			CK73GB1H103K	CHIP C 0.010UF K	E3E4	J700			E63-0953-05	RCA PIN JACK (L/R)	
C521			CK73GB1H103K	CHIP C 0.010UF K	E5K1K2	W501	*		E30-6809-05	CORD WITH PLUG (ANT)	E5R1K1
C521			CK73GB1H103K	CHIP C 0.010UF K	KR1E1	W501	*		E30-6809-05	CORD WITH PLUG (ANT)	KM1M2
C522			CD04AS1V100M	ELECTRO 10UF 35WV	E2M1M2	W501	*		E30-6809-05	CORD WITH PLUG (ANT)	K2
C522			CD04AS1V100M	ELECTRO 10UF 35WV	E3E4	W501	*		E30-6809-05	CORD WITH PLUG (ANT)	X1E1E2
C522			CD04AS1V100M	ELECTRO 10UF 35WV	E5K1K2	257	*		F12-0962-04	SHIELDING TUBE (IN F/E CASE)	
C523			CC73GCH1H331J	CHIP C 330PF J	KR1E1	F1			F53-0297-05	FUSE (UL,CSA) 1.6A	
C523			CC73GCH1H331J	CHIP C 330PF J	E2M1M2	F2			F53-0306-05	FUSE (UL,CSA) 5A	E4K2
C523			CC73GCH1H331J	CHIP C 330PF J	E3E4	F2			F53-0306-05	FUSE (UL,CSA) 5A	E5R1K1
C523			CC73GCH1H331J	CHIP C 330PF J	E5K1K2	F2			F53-0306-05	FUSE (UL,CSA) 5A	KM1M2
C523			CC73GCH1H331J	CHIP C 330PF J	KR1E1	F2			F53-0306-05	FUSE (UL,CSA) 5A	X1E1E2
C524			CD04AS1V100M	ELECTRO 10UF 35WV	E2M1M2	L1			L33-2319-05	CHOKE COIL ASSY	
C524			CD04AS1V100M	ELECTRO 10UF 35WV	E3E4	L100			L92-0319-05	CHIP FERRITE	
C524			CD04AS1V100M	ELECTRO 10UF 35WV	E5K1K2	L101			L41-4795-33	SMALL FIXED INDUCTOR (4.7U)	
C524			CD04AS1V100M	ELECTRO 10UF 35WV	KR1E1	L501-504			L41-4795-33	SMALL FIXED INDUCTOR (4.7U)	
C526,527			CK73GB1H103K	CHIP C 0.010UF K	E2M1M2	L508			L41-4795-33	SMALL FIXED INDUCTOR (4.7U)	E2M1M2
C526,527			CK73GB1H103K	CHIP C 0.010UF K	E3E4	L508			L41-4795-33	SMALL FIXED INDUCTOR (4.7U)	E3E4
C526,527			CK73GB1H103K	CHIP C 0.010UF K	E5K1K2	L508			L41-4795-33	SMALL FIXED INDUCTOR (4.7U)	E5K1K2
C526,527			CK73GB1H103K	CHIP C 0.010UF K	KR1E1	L508			L41-4795-33	SMALL FIXED INDUCTOR (4.7U)	KR1E1
C527			CK73GB1H103K	CHIP C 0.010UF K	X1	L509			L92-0329-05	CHIP FERRITE	E3E4
C600			C90-6779-05	ELECTRO 0.47UF 16WV		X100	*		L77-2974-05	CRYSTAL RESONATOR (11.0592MHZ)	
C602			C90-6779-05	ELECTRO 0.47UF 16WV		X101			L77-2921-05	CRYSTAL RESONATOR (32.768KHZ)	
C616			CK73GB1A105K	CHIP C 1.0UF K		X500			L77-2002-05	CRYSTAL RESONATOR	E2M1M2
C619			CD04BM1E330M	ELECTRO 33UF 25WV							

E1: DDX5022 E2: DDX5022Y E3: DNX5220BT E4: DNX5220 E5: DDX52RY (Europe)
 K: DDX512 K1: DNX5120 K2: DNX512EX (North America)
 X1: DDX5032 (Australia) R1: DDX5032 (Latin America)
 M1: DDX5032 M2: DDX5032M (Other Areas)

△ Indicates safety critical components.

PARTS LIST

ELECTRIC UNIT (X34-575x-xx)

Ref. No.	Ad	New	Parts No.	Description	Destination	Ref. No.	Ad	New	Parts No.	Description	Destination
X500			L77-2002-05	CRYSTAL RESONATOR	E3E4	R44			RK73GB2A683J	CHIP R 68K J 1/10W	
X500			L77-2002-05	CRYSTAL RESONATOR	E5K1K2	R46			RK73EB2E103J	CHIP R 10K J 1/4W	
X500			L77-2002-05	CRYSTAL RESONATOR	KR1E1	R48			RK73GB2A473J	CHIP R 47K J 1/10W	
B	2D		N35-2604-43	BINDING HEAD MACHINE SCREW	E4K2	R49,50			RK73GB2A104J	CHIP R 100K J 1/10W	
B	2D		N35-2604-43	BINDING HEAD MACHINE SCREW	E5R1K1	R51			RK73GB2A473J	CHIP R 47K J 1/10W	
B	2D		N35-2604-43	BINDING HEAD MACHINE SCREW	KM1M2	R52			RK73GB2A472J	CHIP R 4.7K J 1/10W	
B	2D		N35-2604-43	BINDING HEAD MACHINE SCREW	X1E1E2	R53			RK73GB2A473J	CHIP R 47K J 1/10W	
K	3D	*	N09-6727-05	TAPTITE SCREW		R54			RK73GB2A153J	CHIP R 15K J 1/10W	
L	2D		N82-3008-48	BINDING HEAD TAPTITE SCREW		R55			RK73GB2A561J	CHIP R 560 J 1/10W	
R2			RK73FB2B221J	CHIP R 220 J 1/8W		R56			RK73EB2E622J	CHIP R 6.2K J 1/4W	
R3			RK73GB2A103J	CHIP R 10K J 1/10W		R57			RK73GB2A912J	CHIP R 9.1K J 1/10W	
R5			RK73FB2B223J	CHIP R 22K J 1/8W		R58			RK73GB2A105J	CHIP R 1.0M J 1/10W	
R6			RK73EB2E272J	CHIP R 2.7K J 1/4W		R59			RK73EB2E622J	CHIP R 6.2K J 1/4W	
R7			RK73GB2A101J	CHIP R 100 J 1/10W		R100			RK73GB2A101J	CHIP R 100 J 1/10W	
R8			RK73GB2A102J	CHIP R 1.0K J 1/10W		R101			RK73GB2A104J	CHIP R 100K J 1/10W	E4
R9			RK73GB2A101J	CHIP R 100 J 1/10W		R101			RK73GB2A104J	CHIP R 100K J 1/10W	K1K2E3
R10			RK73GB2A473J	CHIP R 47K J 1/10W		R102			RK73GB2A473J	CHIP R 47K J 1/10W	
R11			RK73GB2A100J	CHIP R 10 J 1/10W	E4	R106			RK73GB2A473J	CHIP R 47K J 1/10W	
R11			RK73GB2A100J	CHIP R 10 J 1/10W	K1K2E3	R107			RK73GB2A101J	CHIP R 100 J 1/10W	E4
R12			RK73FB2B472J	CHIP R 4.7K J 1/8W		R107			RK73GB2A101J	CHIP R 100 J 1/10W	K1K2E3
R13			RK73GB2A223J	CHIP R 22K J 1/10W		R109			RK73GB2A473J	CHIP R 47K J 1/10W	E1E2M1
R14			RK73PB2H102J	CHIP R 1.0K J 1/2W		R109			RK73GB2A473J	CHIP R 47K J 1/10W	E3E4
R15			RK73GB2A473J	CHIP R 47K J 1/10W		R109			RK73GB2A473J	CHIP R 47K J 1/10W	M2X1E5
R16			RK73PB2H102J	CHIP R 1.0K J 1/2W		R110			RK73GB2A104J	CHIP R 100K J 1/10W	E4
R17			RK73GB2A103J	CHIP R 10K J 1/10W		R110			RK73GB2A104J	CHIP R 100K J 1/10W	K1K2E3
R18			RK73EB2E103J	CHIP R 10K J 1/4W		R112			RK73GB2A472J	CHIP R 4.7K J 1/10W	
R19			RK73GB2A000J	CHIP R 0.0 J 1/10W	E1E2E5	R113			RK73GB2A473J	CHIP R 47K J 1/10W	
R19			RK73GB2A000J	CHIP R 0.0 J 1/10W	E3E4	R114			RK73GB2A101J	CHIP R 100 J 1/10W	E1E2M1
R20			RK73GB2A100J	CHIP R 10 J 1/10W		R114			RK73GB2A101J	CHIP R 100 J 1/10W	E3E4
R21			RK73GB2A223J	CHIP R 22K J 1/10W		R114			RK73GB2A101J	CHIP R 100 J 1/10W	M2X1E5
R22			RK73EB2E272J	CHIP R 2.7K J 1/4W		R115			RK73GB2A100J	CHIP R 10 J 1/10W	E4
R23			RK73GH2A243D	CHIP R 24K D 1/10W		R115			RK73GB2A100J	CHIP R 10 J 1/10W	K1K2E3
R24			RK73GH2A432D	CHIP R 4.3K D 1/10W		R118			RK73GB2A000J	CHIP R 0.0 J 1/10W	
R25			RK73FB2B222J	CHIP R 2.2K J 1/8W		R119			RK73GH2A333D	CHIP R 33K D 1/10W	
R26			RK73GB2A102J	CHIP R 1.0K J 1/10W		R120			RK73GH2A222D	CHIP R 2.2K D 1/10W	
R27			RK73GB2A103J	CHIP R 10K J 1/10W	KR1M1	R121			RK73GH2A153D	CHIP R 15K D 1/10W	
R27			RK73GB2A103J	CHIP R 10K J 1/10W	K2	R122			RK73GB2A105J	CHIP R 1.0M J 1/10W	
R27			RK73GB2A103J	CHIP R 10K J 1/10W	M2X1K1	R125			RK73GB2A473J	CHIP R 47K J 1/10W	E1E2M1
R28			RK73GB2A222J	CHIP R 2.2K J 1/10W	KR1M1	R125			RK73GB2A473J	CHIP R 47K J 1/10W	E3E4
R28			RK73GB2A222J	CHIP R 2.2K J 1/10W	K2	R125			RK73GB2A473J	CHIP R 47K J 1/10W	M2X1E5
R28			RK73GB2A222J	CHIP R 2.2K J 1/10W	M2X1K1	R126,127			RK73GB2A103J	CHIP R 10K J 1/10W	
R29			RK73GB2A105J	CHIP R 1.0M J 1/10W		R128			RK73GB2A473J	CHIP R 47K J 1/10W	KR1K1
R30			RK73EB2E102J	CHIP R 1.0K J 1/4W		R128			RK73GB2A473J	CHIP R 47K J 1/10W	K2
R31			RK73FB2B472J	CHIP R 4.7K J 1/8W		R128-131			RK73GB2A473J	CHIP R 47K J 1/10W	E1E2M1
R32			RK73GB2A104J	CHIP R 100K J 1/10W		R128-131			RK73GB2A473J	CHIP R 47K J 1/10W	E3E4
R33,34			RK73PB2H102J	CHIP R 1.0K J 1/2W	KR1M1	R128-131			RK73GB2A473J	CHIP R 47K J 1/10W	M2X1E5
R33,34			RK73PB2H102J	CHIP R 1.0K J 1/2W	K2	R130,131			RK73GB2A473J	CHIP R 47K J 1/10W	KR1K1
R33,34			RK73PB2H102J	CHIP R 1.0K J 1/2W	M2X1K1	R130,131			RK73GB2A473J	CHIP R 47K J 1/10W	K2
R35			RK73GB2A103J	CHIP R 10K J 1/10W	KR1M1	R133,134			RK73GB2A473J	CHIP R 47K J 1/10W	
R35			RK73GB2A103J	CHIP R 10K J 1/10W	K2	R135			RK73GB2A101J	CHIP R 100 J 1/10W	
R35			RK73GB2A103J	CHIP R 10K J 1/10W	M2X1K1	R136			RK73GB2A222J	CHIP R 2.2K J 1/10W	
R36			RK73GB2A153J	CHIP R 15K J 1/10W		R137-142			RK73GB2A101J	CHIP R 100 J 1/10W	E1E2M1
R37			RK73GB2A103J	CHIP R 10K J 1/10W		R137-142			RK73GB2A101J	CHIP R 100 J 1/10W	E3E4
R38			RK73GB2A822J	CHIP R 8.2K J 1/10W		R137-142			RK73GB2A101J	CHIP R 100 J 1/10W	M2X1E5
						R139-141			RK73GB2A101J	CHIP R 100 J 1/10W	KR1K1

E1: DDX5022 E2: DDX5022Y E3: DNX5220BT E4: DNX5220 E5: DDX52RY (Europe) △Indicates safety critical components.

K: DDX512 K1: DNX5120 K2: DNX512EX (North America)

X1: DDX5032 (Australia) R1: DDX5032 (Latin America)

M1: DDX5032 M2: DDX5032M (Other Areas)

PARTS LIST

ELECTRIC UNIT (X34-575x-xx)

Ref. No.	Add	New	Parts No.	Description	Destination	Ref. No.	Add	New	Parts No.	Description	Destination
R139-141			RK73GB2A101J	CHIP R 100 J 1/10W	K2	R188			RK73GB2A222J	CHIP R 2.2K J 1/10W	E3E4
R143			RK73GB2A102J	CHIP R 1.0K J 1/10W		R188			RK73GB2A222J	CHIP R 2.2K J 1/10W	E5K1K2
R144			RK73GB2A472J	CHIP R 4.7K J 1/10W		R188			RK73GB2A222J	CHIP R 2.2K J 1/10W	KR1E1
R145			RK73GB2A473J	CHIP R 47K J 1/10W		R189			RK73GB2A103J	CHIP R 10K J 1/10W	X1
R146,147			RK73GB2A101J	CHIP R 100 J 1/10W		R190			RK73GB2A222J	CHIP R 2.2K J 1/10W	
R148			RK73GB2A102J	CHIP R 1.0K J 1/10W		R191,192			RK73GB2A102J	CHIP R 1.0K J 1/10W	
R149			RK73GB2A101J	CHIP R 100 J 1/10W		R193			RK73GB2A101J	CHIP R 100 J 1/10W	
R150			RK73GB2A302J	CHIP R 3.0K J 1/10W		R194			RK73GB2A102J	CHIP R 1.0K J 1/10W	
R151			RK73GB2A623J	CHIP R 62K J 1/10W		R195			RK73GB2A153J	CHIP R 15K J 1/10W	
R152			RK73GB2A101J	CHIP R 100 J 1/10W		R196			RK73GB2A103J	CHIP R 10K J 1/10W	E4
R153			RK73GB2A222J	CHIP R 2.2K J 1/10W		R196			RK73GB2A103J	CHIP R 10K J 1/10W	R1E1E2
R154			RK73GB2A101J	CHIP R 100 J 1/10W		R196			RK73GB2A103J	CHIP R 10K J 1/10W	X1E5E3
R155			RK73GB2A000J	CHIP R 0.0 J 1/10W		R196,197			RK73GB2A103J	CHIP R 10K J 1/10W	M1M2
R156			RK73GB2A101J	CHIP R 100 J 1/10W		R197			RK73GB2A103J	CHIP R 10K J 1/10W	KK1K2
R157			RK73GB2A473J	CHIP R 47K J 1/10W	KR1K1	R197			RK73GB2A303J	CHIP R 30K J 1/10W	X1
R157			RK73GB2A473J	CHIP R 47K J 1/10W	K2	R197			RK73GB2A332J	CHIP R 3.3K J 1/10W	E1E2E5
R157-159			RK73GB2A473J	CHIP R 47K J 1/10W	E1E2M1	R197			RK73GB2A332J	CHIP R 3.3K J 1/10W	E3E4
R157-159			RK73GB2A473J	CHIP R 47K J 1/10W	E3E4	R198			RK73GB2A102J	CHIP R 1.0K J 1/10W	
R157-159			RK73GB2A473J	CHIP R 47K J 1/10W	M2X1E5	R200			RK73GB2A101J	CHIP R 100 J 1/10W	
R159			RK73GB2A473J	CHIP R 47K J 1/10W	KR1K1	R202			RK73GB2A153J	CHIP R 15K J 1/10W	
R159			RK73GB2A473J	CHIP R 47K J 1/10W	K2	R203			RK73GB2A101J	CHIP R 100 J 1/10W	
R160			RK73GB2A101J	CHIP R 100 J 1/10W		R208			RK73GB2A472J	CHIP R 4.7K J 1/10W	
R161			RK73GB2A222J	CHIP R 2.2K J 1/10W		R209-213			RK73GB2A101J	CHIP R 100 J 1/10W	
R164			RK73GB2A471J	CHIP R 470 J 1/10W		R215			RK73GB2A103J	CHIP R 10K J 1/10W	E4K2
R165			RK73GB2A682J	CHIP R 6.8K J 1/10W		R215			RK73GB2A103J	CHIP R 10K J 1/10W	E5R1K1
R166			RK73GB2A472J	CHIP R 4.7K J 1/10W		R215			RK73GB2A103J	CHIP R 10K J 1/10W	KM1M2
R168			RK73GB2A471J	CHIP R 470 J 1/10W		R215			RK73GB2A103J	CHIP R 10K J 1/10W	X1E1E2
R169			RK73GB2A104J	CHIP R 100K J 1/10W		R216			RK73GB2A103J	CHIP R 10K J 1/10W	E3
R170			RK73GB2A472J	CHIP R 4.7K J 1/10W		R222			RK73GB2A104J	CHIP R 100K J 1/10W	
R172			RK73GB2A101J	CHIP R 100 J 1/10W	E2M1M2	R223			RK73GB2A101J	CHIP R 100 J 1/10W	
R172			RK73GB2A101J	CHIP R 100 J 1/10W	E3E4	R224			RK73GB2A473J	CHIP R 47K J 1/10W	
R172			RK73GB2A101J	CHIP R 100 J 1/10W	E5K1K2	R225,226			RK73GB2A101J	CHIP R 100 J 1/10W	E1E2M1
R172			RK73GB2A101J	CHIP R 100 J 1/10W	KR1E1	R225,226			RK73GB2A101J	CHIP R 100 J 1/10W	E3E4
R173			RK73GB2A682J	CHIP R 6.8K J 1/10W		R225,226			RK73GB2A101J	CHIP R 100 J 1/10W	M2X1E5
R174,175			RK73GB2A473J	CHIP R 47K J 1/10W	E2M1M2	R226			RK73GB2A101J	CHIP R 100 J 1/10W	KR1K1
R174,175			RK73GB2A473J	CHIP R 47K J 1/10W	E3E4	R226			RK73GB2A101J	CHIP R 100 J 1/10W	K2
R174,175			RK73GB2A473J	CHIP R 47K J 1/10W	E5K1K2	R227			RK73GB2A104J	CHIP R 100K J 1/10W	E1E2M1
R174,175			RK73GB2A473J	CHIP R 47K J 1/10W	KR1E1	R227			RK73GB2A104J	CHIP R 100K J 1/10W	E3E4
R175			RK73GB2A473J	CHIP R 47K J 1/10W	X1	R227			RK73GB2A104J	CHIP R 100K J 1/10W	M2X1E5
R177			RK73GB2A473J	CHIP R 47K J 1/10W	E2M1M2	R228-233			RK73GB2A101J	CHIP R 100 J 1/10W	
R177			RK73GB2A473J	CHIP R 47K J 1/10W	E3E4	R234,235			RK73GB2A102J	CHIP R 1.0K J 1/10W	
R177			RK73GB2A473J	CHIP R 47K J 1/10W	E5K1K2	R236			RK73GB2A104J	CHIP R 100K J 1/10W	
R177			RK73GB2A473J	CHIP R 47K J 1/10W	KR1E1	R237			RK73GB2A473J	CHIP R 47K J 1/10W	
R180			RK73GB2A103J	CHIP R 10K J 1/10W		R238-253			RK73GB2A101J	CHIP R 100 J 1/10W	
R181			RK73GB2A104J	CHIP R 100K J 1/10W		R254			RK73GB2A473J	CHIP R 47K J 1/10W	
R182			RK73GB2A103J	CHIP R 10K J 1/10W	E4	R255-258			RK73GB2A104J	CHIP R 100K J 1/10W	
R182			RK73GB2A103J	CHIP R 10K J 1/10W	K1K2E3	R259			RK73GB2A153J	CHIP R 15K J 1/10W	
R183			RK73GB2A473J	CHIP R 47K J 1/10W		R260,261			RK73GB2A104J	CHIP R 100K J 1/10W	
R184			RK73GB2A103J	CHIP R 10K J 1/10W	E5R1	R263			RK73GB2A103J	CHIP R 10K J 1/10W	
R184			RK73GB2A103J	CHIP R 10K J 1/10W	KM1M2	R302			RK73EB2E2R2J	CHIP R 2.2 J 1/4W	
R184			RK73GB2A103J	CHIP R 10K J 1/10W	X1E1E2	R303-306			RK73GB2A000J	CHIP R 0.0 J 1/10W	
R185			RK73GB2A222J	CHIP R 2.2K J 1/10W		R307-310			RK73GB2A101J	CHIP R 100 J 1/10W	
R186			RK73GB2A223J	CHIP R 22K J 1/10W		R311,312			RK73GB2A103J	CHIP R 10K J 1/10W	
R187			RK73GB2A473J	CHIP R 47K J 1/10W		R317			RK73GB2A102J	CHIP R 1.0K J 1/10W	
R188			RK73GB2A222J	CHIP R 2.2K J 1/10W	E2M1M2	R318			RK73GB2A104J	CHIP R 100K J 1/10W	

E1: DDX5022 E2: DDX5022Y E3: DNX5220BT E4: DNX5220 E5: DDX52RY (Europe) △ Indicates safety critical components.
 K: DDX512 K1: DNX5120 K2: DNX512EX (North America)
 X1: DDX5032 (Australia) R1: DDX5032 (Latin America)
 M1: DDX5032 M2: DDX5032M (Other Areas)

PARTS LIST

ELECTRIC UNIT (X34-575x-xx)

Ref. No.	A	N	Parts No.	Description	Desti- nation	Ref. No.	A	N	Parts No.	Description	Desti- nation
R319,320			RK73GB2A102J	CHIP R 1.0K J 1/10W		R440			RK73EB2E101J	CHIP R 100 J 1/4W	X1E1E2
R321,322			RK73GB2A103J	CHIP R 10K J 1/10W		R441			RK73EB2E432J	CHIP R 4.3K J 1/4W	E4K2
R323,324			RK73GB2A101J	CHIP R 100 J 1/10W		R441			RK73EB2E432J	CHIP R 4.3K J 1/4W	E5R1K1
R325-327			RK73GB2A103J	CHIP R 10K J 1/10W		R441			RK73EB2E432J	CHIP R 4.3K J 1/4W	KM1M2
R329			RK73GB2A103J	CHIP R 10K J 1/10W		R441			RK73EB2E432J	CHIP R 4.3K J 1/4W	X1E1E2
R400,401			RK73GB2A100J	CHIP R 10 J 1/10W	E1E2M1	R442			RK73EB2E100J	CHIP R 10 J 1/4W	E4K2
R400,401			RK73GB2A100J	CHIP R 10 J 1/10W	E3E4	R442			RK73EB2E100J	CHIP R 10 J 1/4W	E5R1K1
R400,401			RK73GB2A100J	CHIP R 10 J 1/10W	M2X1E5	R442			RK73EB2E100J	CHIP R 10 J 1/4W	KM1M2
R402			RK73GB2A222J	CHIP R 2.2K J 1/10W	E1E2M1	R442			RK73EB2E100J	CHIP R 10 J 1/4W	X1E1E2
R402			RK73GB2A222J	CHIP R 2.2K J 1/10W	E3E4	R443			RK73EB2E4R7J	CHIP R 4.7 J 1/4W	E4K2
R402			RK73GB2A222J	CHIP R 2.2K J 1/10W	M2X1E5	R443			RK73EB2E4R7J	CHIP R 4.7 J 1/4W	E5R1K1
R403			RK73GB2A102J	CHIP R 1.0K J 1/10W	E1E2M1	R443			RK73EB2E4R7J	CHIP R 4.7 J 1/4W	KM1M2
R403			RK73GB2A102J	CHIP R 1.0K J 1/10W	E3E4	R443			RK73EB2E4R7J	CHIP R 4.7 J 1/4W	X1E1E2
R403			RK73GB2A102J	CHIP R 1.0K J 1/10W	M2X1E5	R444			RK73EB2E100J	CHIP R 10 J 1/4W	E4K2
R404,405			RK73GB2A100J	CHIP R 10 J 1/10W	E1E2M1	R444			RK73EB2E100J	CHIP R 10 J 1/4W	E5R1K1
R404,405			RK73GB2A100J	CHIP R 10 J 1/10W	E3E4	R444			RK73EB2E100J	CHIP R 10 J 1/4W	KM1M2
R404,405			RK73GB2A100J	CHIP R 10 J 1/10W	M2X1E5	R444			RK73EB2E100J	CHIP R 10 J 1/4W	X1E1E2
R406			RK73EB2E100J	CHIP R 10 J 1/4W	E1E2M1	R445			RK73GB2A100J	CHIP R 10 J 1/10W	E4K2
R406			RK73EB2E100J	CHIP R 10 J 1/4W	E3E4	R445			RK73GB2A100J	CHIP R 10 J 1/10W	E5R1K1
R406			RK73EB2E100J	CHIP R 10 J 1/4W	M2X1E5	R445			RK73GB2A100J	CHIP R 10 J 1/10W	KM1M2
R407			RK73EB2E4R7J	CHIP R 4.7 J 1/4W	E1E2M1	R445			RK73GB2A100J	CHIP R 10 J 1/10W	X1E1E2
R407			RK73EB2E4R7J	CHIP R 4.7 J 1/4W	E3E4	R446			RK73GB2A473J	CHIP R 47K J 1/10W	E4K2
R407			RK73EB2E4R7J	CHIP R 4.7 J 1/4W	M2X1E5	R446			RK73GB2A473J	CHIP R 47K J 1/10W	E5R1K1
R408			RK73EB2E100J	CHIP R 10 J 1/4W	E1E2M1	R446			RK73GB2A473J	CHIP R 47K J 1/10W	KM1M2
R408			RK73EB2E100J	CHIP R 10 J 1/4W	E3E4	R446			RK73GB2A473J	CHIP R 47K J 1/10W	X1E1E2
R408			RK73EB2E100J	CHIP R 10 J 1/4W	M2X1E5	R447			RK73GB2A104J	CHIP R 100K J 1/10W	E4K2
R409-411			RK73EB2E102J	CHIP R 1.0K J 1/4W	E1E2M1	R447			RK73GB2A104J	CHIP R 100K J 1/10W	E5R1K1
R409-411			RK73EB2E102J	CHIP R 1.0K J 1/4W	E3E4	R447			RK73GB2A104J	CHIP R 100K J 1/10W	KM1M2
R409-411			RK73EB2E102J	CHIP R 1.0K J 1/4W	M2X1E5	R447			RK73GB2A104J	CHIP R 100K J 1/10W	X1E1E2
R412-414			RK73EB2E101J	CHIP R 100 J 1/4W	E1E2M1	R448			RK73GB2A473J	CHIP R 47K J 1/10W	E4K2
R412-414			RK73EB2E101J	CHIP R 100 J 1/4W	E3E4	R448			RK73GB2A473J	CHIP R 47K J 1/10W	E5R1K1
R412-414			RK73EB2E101J	CHIP R 100 J 1/4W	M2X1E5	R448			RK73GB2A473J	CHIP R 47K J 1/10W	KM1M2
R415,416			RK73EB2E102J	CHIP R 1.0K J 1/4W	E1E2M1	R448			RK73GB2A473J	CHIP R 47K J 1/10W	X1E1E2
R415,416			RK73EB2E102J	CHIP R 1.0K J 1/4W	E3E4	R451-453			RK73GB2A100J	CHIP R 10 J 1/10W	E4K2
R415,416			RK73EB2E102J	CHIP R 1.0K J 1/4W	M2X1E5	R451-453			RK73GB2A100J	CHIP R 10 J 1/10W	E5R1K1
R417			RK73EB2E101J	CHIP R 100 J 1/4W	E1E2M1	R451-453			RK73GB2A100J	CHIP R 10 J 1/10W	KM1M2
R417			RK73EB2E101J	CHIP R 100 J 1/4W	E3E4	R451-453			RK73GB2A100J	CHIP R 10 J 1/10W	X1E1E2
R417			RK73EB2E101J	CHIP R 100 J 1/4W	M2X1E5	R454			RK73GB2A102J	CHIP R 1.0K J 1/10W	E4K2
R418			RK73GB2A100J	CHIP R 10 J 1/10W	E1E2M1	R454			RK73GB2A102J	CHIP R 1.0K J 1/10W	E5R1K1
R418			RK73GB2A100J	CHIP R 10 J 1/10W	E3E4	R454			RK73GB2A102J	CHIP R 1.0K J 1/10W	KM1M2
R418			RK73GB2A100J	CHIP R 10 J 1/10W	M2X1E5	R454			RK73GB2A102J	CHIP R 1.0K J 1/10W	X1E1E2
R419			RK73GB2A750J	CHIP R 75 J 1/10W	E1E2M1	R455			RK73GB2A222J	CHIP R 2.2K J 1/10W	E4K2
R419			RK73GB2A750J	CHIP R 75 J 1/10W	E3E4	R455			RK73GB2A222J	CHIP R 2.2K J 1/10W	E5R1K1
R419			RK73GB2A750J	CHIP R 75 J 1/10W	M2X1E5	R455			RK73GB2A222J	CHIP R 2.2K J 1/10W	KM1M2
R438			RK73EB2E432J	CHIP R 4.3K J 1/4W	E4K2	R455			RK73GB2A222J	CHIP R 2.2K J 1/10W	X1E1E2
R438			RK73EB2E432J	CHIP R 4.3K J 1/4W	E5R1K1	R456			RK73EB2E103J	CHIP R 10K J 1/4W	E4K2
R438			RK73EB2E432J	CHIP R 4.3K J 1/4W	KM1M2	R456			RK73EB2E103J	CHIP R 10K J 1/4W	E5R1K1
R438			RK73EB2E432J	CHIP R 4.3K J 1/4W	X1E1E2	R456			RK73EB2E103J	CHIP R 10K J 1/4W	KM1M2
R439			RK73EB2E472J	CHIP R 4.7K J 1/4W	E4K2	R456			RK73EB2E103J	CHIP R 10K J 1/4W	X1E1E2
R439			RK73EB2E472J	CHIP R 4.7K J 1/4W	E5R1K1	R458			RK73GB2A104J	CHIP R 100K J 1/10W	
R439			RK73EB2E472J	CHIP R 4.7K J 1/4W	KM1M2	R500			RK73FB2B152J	CHIP R 1.5K J 1/8W	
R439			RK73EB2E472J	CHIP R 4.7K J 1/4W	X1E1E2	R501			RK73GB2A102J	CHIP R 1.0K J 1/10W	
R440			RK73EB2E101J	CHIP R 100 J 1/4W	E4K2	R502			RK73GB2A223J	CHIP R 22K J 1/10W	
R440			RK73EB2E101J	CHIP R 100 J 1/4W	E5R1K1	R503			RK73GB2A100J	CHIP R 10 J 1/10W	
R440			RK73EB2E101J	CHIP R 100 J 1/4W	KM1M2	R505-507			RK73GB2A222J	CHIP R 2.2K J 1/10W	E2M1M2

E1: DDX5022 E2: DDX5022Y E3: DNX5220BT E4: DNX5220 E5: DDX52RY (Europe) △Indicates safety critical components.

K: DDX512 K1: DNX5120 K2: DNX512EX (North America)

X1: DDX5032 (Australia) R1: DDX5032 (Latin America)

M1: DDX5032 M2: DDX5032M (Other Areas)

PARTS LIST

ELECTRIC UNIT (X34-575x-xx)

Ref. No.	Add	New	Parts No.	Description	Destination	Ref. No.	Add	New	Parts No.	Description	Destination
R505-507			RK73GB2A222J	CHIP R 2.2K J 1/10W	E3E4	W310,311			R92-1252-05	CHIP R 0 OHM J 1/16W	E5R1K1
R505-507			RK73GB2A222J	CHIP R 2.2K J 1/10W	E5K1K2	W310,311			R92-1252-05	CHIP R 0 OHM J 1/16W	KM1M2
R505-507			RK73GB2A222J	CHIP R 2.2K J 1/10W	KR1E1	W310,311			R92-1252-05	CHIP R 0 OHM J 1/16W	X1E1E2
R600,601			RK73GB2A470J	CHIP R 47 J 1/10W		W800			R92-1252-05	CHIP R 0 OHM J 1/16W	
R603,604			RK73GB2A470J	CHIP R 47 J 1/10W		W802			R92-1252-05	CHIP R 0 OHM J 1/16W	
R605			RK73GB2A333J	CHIP R 33K J 1/10W		D1			RB160L-40	DIODE	
R606			RK73GB2A331J	CHIP R 330 J 1/10W		D2			UDZS5.6B	ZENER DIODE	
R607			RK73GB2A682J	CHIP R 6.8K J 1/10W		D3			DAP202U	DIODE	
R608			RK73GB2A221J	CHIP R 220 J 1/10W		D4			DAN202U	DIODE	
R609			RK73GB2A223J	CHIP R 22K J 1/10W		D6,7			1SR154-400	DIODE	
R610			RK73GB2A432J	CHIP R 4.3K J 1/10W		D8			DAN202U	DIODE	
R611			RK73GB2A100J	CHIP R 10 J 1/10W		D9			1SR154-400	DIODE	
R700			RK73FB2B101J	CHIP R 100 J 1/8W		D10			DAN202U	DIODE	
R701			RK73GB2A471J	CHIP R 470 J 1/10W		D11			1SR154-400	DIODE	
R702			RK73GB2A223J	CHIP R 22K J 1/10W		D12			UDZS6.2B	ZENER DIODE	
R705			RK73GB2A223J	CHIP R 22K J 1/10W		D13			UDZS6.8B	ZENER DIODE	
R707			RK73FB2B101J	CHIP R 100 J 1/8W		D15			UDZS6.8B	ZENER DIODE	
R708			RK73GB2A471J	CHIP R 470 J 1/10W		D17			RM4ZLF-J1NF	DIODE	
R709			RK73FB2B101J	CHIP R 100 J 1/8W		D18			UDZS4.7B	ZENER DIODE	
R710			RK73GB2A471J	CHIP R 470 J 1/10W		D19			UDZS6.2B	ZENER DIODE	
R712			RK73GB2A223J	CHIP R 22K J 1/10W		D20			DAN202U	DIODE	
R716			RK73GB2A223J	CHIP R 22K J 1/10W		D300,301			DAP202U	DIODE	
R717			RK73FB2B101J	CHIP R 100 J 1/8W		D302,303			UDZS6.8B	ZENER DIODE	
R718			RK73GB2A471J	CHIP R 470 J 1/10W		D304-306			DAP202U	DIODE	
R719			RK73FB2B101J	CHIP R 100 J 1/8W		D307			UDZS6.8B	ZENER DIODE	
R720			RK73GB2A471J	CHIP R 470 J 1/10W		D400			UDZS4.7B	ZENER DIODE	E1E2M1
R721			RK73GB2A223J	CHIP R 22K J 1/10W		D400			UDZS4.7B	ZENER DIODE	E3E4
R724			RK73GB2A223J	CHIP R 22K J 1/10W		D400			UDZS4.7B	ZENER DIODE	M2X1E5
R725			RK73FB2B101J	CHIP R 100 J 1/8W		D401			DAP202U	DIODE	E1E2M1
R726			RK73GB2A471J	CHIP R 470 J 1/10W		D401			DAP202U	DIODE	E3E4
R800,801			RK73GB2A102J	CHIP R 1.0K J 1/10W		D401			DAP202U	DIODE	M2X1E5
R802-811			RK73GB2A101J	CHIP R 100 J 1/10W		D402,403			UDZS6.2B	ZENER DIODE	E1E2M1
R812			RK73GB2A102J	CHIP R 1.0K J 1/10W		D402,403			UDZS6.2B	ZENER DIODE	E3E4
R813			RK73FB2B100J	CHIP R 10 J 1/8W		D402,403			UDZS6.2B	ZENER DIODE	M2X1E5
R814			RK73FB2B4R7J	CHIP R 4.7 J 1/8W		D404,405			UDZS6.8B	ZENER DIODE	E1E2M1
R818			RK73FB2B100J	CHIP R 10 J 1/8W		D404,405			UDZS6.8B	ZENER DIODE	E3E4
R819,820			RK73GB2A103J	CHIP R 10K J 1/10W		D404,405			UDZS6.8B	ZENER DIODE	M2X1E5
R821			RK73GB2A000J	CHIP R 0.0 J 1/10W		D406-413			UDZS6.2B	ZENER DIODE	E1E2M1
R822			RK73FB2B821J	CHIP R 820 J 1/8W		D406-413			UDZS6.2B	ZENER DIODE	E3E4
R823			RK73GB2A100J	CHIP R 10 J 1/10W		D406-413			UDZS6.2B	ZENER DIODE	M2X1E5
W4			R92-1252-05	CHIP R 0 OHM J 1/16W		D417			UDZS6.2B	ZENER DIODE	E1E2M1
W100			R92-1252-05	CHIP R 0 OHM J 1/16W		D417			UDZS6.2B	ZENER DIODE	E3E4
W102-104			R92-1252-05	CHIP R 0 OHM J 1/16W	E5R1	D417			UDZS6.2B	ZENER DIODE	M2X1E5
W102-104			R92-1252-05	CHIP R 0 OHM J 1/16W	KM1M2	D418			DA204U	DIODE	
W102-104			R92-1252-05	CHIP R 0 OHM J 1/16W	X1E1E2	D419-421			UDZS6.2B	ZENER DIODE	E4K2
W102,103			R92-1252-05	CHIP R 0 OHM J 1/16W	E4	D419-421			UDZS6.2B	ZENER DIODE	E5R1K1
W102,103			R92-1252-05	CHIP R 0 OHM J 1/16W	K1K2E3	D419-421			UDZS6.2B	ZENER DIODE	KM1M2
W105			R92-2052-05	CHIP R 0 OHM J 1/10W		D419-421			UDZS6.2B	ZENER DIODE	X1E1E2
W300-303			R92-1252-05	CHIP R 0 OHM J 1/16W	KR1K1	D422,423			UDZS6.8B	ZENER DIODE	E4K2
W300-303			R92-1252-05	CHIP R 0 OHM J 1/16W	K2	D422,423			UDZS6.8B	ZENER DIODE	E5R1K1
W300,301			R92-1252-05	CHIP R 0 OHM J 1/16W	E1E2M1	D422,423			UDZS6.8B	ZENER DIODE	KM1M2
W300,301			R92-1252-05	CHIP R 0 OHM J 1/16W	E3E4	D422,423			UDZS6.8B	ZENER DIODE	X1E1E2
W300,301			R92-1252-05	CHIP R 0 OHM J 1/16W	M2X1E5	D424-426			UDZS6.2B	ZENER DIODE	E4K2
W304-309			R92-1252-05	CHIP R 0 OHM J 1/16W	E3	D424-426			UDZS6.2B	ZENER DIODE	E5R1K1
W310,311			R92-1252-05	CHIP R 0 OHM J 1/16W	E4K2	D424-426			UDZS6.2B	ZENER DIODE	KM1M2

E1: DDX5022 E2: DDX5022Y E3: DNX5220BT E4: DNX5220 E5: DDX52RY (Europe)
 K: DDX512 K1: DNX5120 K2: DNX512EX (North America)
 X1: DDX5032 (Australia) R1: DDX5032 (Latin America)
 M1: DDX5032 M2: DDX5032M (Other Areas)

△ Indicates safety critical components.

PARTS LIST

ELECTRIC UNIT (X34-575x-xx)

Ref. No.	Ad	New	Parts No.	Description	Desti- nation	Ref. No.	Ad	New	Parts No.	Description	Desti- nation
D424-426			UDZS6.2B	ZENER DIODE	X1E1E2	Q6			DTC143EUA	DIGITAL TRANSISTOR	
D427			UDZS4.7B	ZENER DIODE	E4K2	Q7			DTC144EUA	DIGITAL TRANSISTOR	
D427			UDZS4.7B	ZENER DIODE	E5R1K1	Q8			2SC4081	TRANSISTOR	
D427			UDZS4.7B	ZENER DIODE	KM1M2	Q9			DTA114EUA	DIGITAL TRANSISTOR	
D427			UDZS4.7B	ZENER DIODE	X1E1E2	Q10			2SA1576A	TRANSISTOR	
D430			DAP202U	DIODE	E4K2	Q11			DTC143ZUA	DIGITAL TRANSISTOR	
D430			DAP202U	DIODE	E5R1K1	Q12			2SB1689	TRANSISTOR	
D430			DAP202U	DIODE	KM1M2	Q13			DTC124EUA	DIGITAL TRANSISTOR	
D430			DAP202U	DIODE	X1E1E2	Q14			2SB1188 (R)	TRANSISTOR	KR1M1
D431			1SS355	DIODE	E4K2	Q14			2SB1188 (R)	TRANSISTOR	K2
D431			1SS355	DIODE	E5R1K1	Q14			2SB1188 (R)	TRANSISTOR	M2X1K1
D431			1SS355	DIODE	KM1M2	Q15			DTC144EUA	DIGITAL TRANSISTOR	
D431			1SS355	DIODE	X1E1E2	Q16,17			2SC4081	TRANSISTOR	KR1M1
D500			UDZS9.1B	ZENER DIODE		Q16,17			2SC4081	TRANSISTOR	K2
D600,601			DAP202U	DIODE		Q16,17			2SC4081	TRANSISTOR	M2X1K1
D704-707			DAP202U	DIODE		Q17			2SC4081	TRANSISTOR	E1E2E5
D710,711			DAP202U	DIODE		Q17			2SC4081	TRANSISTOR	E3E4
D712			DA204U	DIODE		Q20			2SC4081	TRANSISTOR	
D802-806			CVS10A120M	VARIATOR		Q21			DTC144EUA	DIGITAL TRANSISTOR	
D808-812			CVS10A120M	VARIATOR		Q22			2SB1689	TRANSISTOR	
D816			UDZS10B	ZENER DIODE		Q23			2SC4081	TRANSISTOR	
IC1			M5237ML-CF0J	ANALOGUE IC		Q24			DTA124EUA	DIGITAL TRANSISTOR	
IC2			R1114N331B-TR	ANALOGUE IC (3.3V LF)		Q25			DTC143ZUA	DIGITAL TRANSISTOR	
IC100			74AHC1G08GW	MOS-IC		Q100			DTC144EUA	DIGITAL TRANSISTOR	E4
IC101			S-80835CNNB-G	MOS-IC		Q100			DTC144EUA	DIGITAL TRANSISTOR	K1K2E3
IC103			W05-1387-00	ROM IC	KK1K2	Q101			2SA1576A	TRANSISTOR	E4
IC103			W05-1388-00	ROM IC	E1E2E3	Q101			2SA1576A	TRANSISTOR	K1K2E3
IC103			W05-1388-00	ROM IC	E4E5	Q102			DTA114EUA	DIGITAL TRANSISTOR	E4
IC103			W05-1389-00	ROM IC	M1M2	Q102			DTA114EUA	DIGITAL TRANSISTOR	K1K2E3
IC103			W05-1390-00	ROM IC	R1X1	Q103,104			DTC114TUA	DIGITAL TRANSISTOR	
IC103			W05-1391-00	ROM IC	V	Q105			DTA114TUA	DIGITAL TRANSISTOR	
IC104	*		30878MJBA21GP	MICROCONTROLLER IC		Q107			DTA114EUA	DIGITAL TRANSISTOR	
IC105	*		74AHCT1G08GW	MOS-IC	E4	Q108			2SC4081	TRANSISTOR	
IC105	*		74AHCT1G08GW	MOS-IC	K1K2E3	Q110			DTA114YUA	DIGITAL TRANSISTOR	
IC302			E-TDA7415CB	ANALOGUE IC		Q111			2SC4081	TRANSISTOR	
IC303,304			TC4052BFT	MOS-IC		Q112			DTC143ZUA	DIGITAL TRANSISTOR	
IC400			NJM2794RB2ZB	ANALOGUE IC	E3	Q113-115			2SC4081	TRANSISTOR	
IC400,401			NJM2794RB2ZB	ANALOGUE IC	E1E2M1	Q116			2SA1576A	TRANSISTOR	
IC400,401			NJM2794RB2ZB	ANALOGUE IC	E4	Q117			2SC4081	TRANSISTOR	
IC400,401			NJM2794RB2ZB	ANALOGUE IC	M2X1E5	Q118			2SA1576A	TRANSISTOR	
IC401			NJM2794RB2ZB	ANALOGUE IC	KR1K1	Q300,301			DTC143ZUA	DIGITAL TRANSISTOR	
IC401			NJM2794RB2ZB	ANALOGUE IC	K2	Q303-305			DTC143ZUA	DIGITAL TRANSISTOR	E1E2M1
IC402			TC7WHU04FU-F	MOS-IC	E1E2M1	Q303-305			DTC143ZUA	DIGITAL TRANSISTOR	E3E4
IC402			TC7WHU04FU-F	MOS-IC	E3E4	Q303-305			DTC143ZUA	DIGITAL TRANSISTOR	M2X1E5
IC402			TC7WHU04FU-F	MOS-IC	M2X1E5	Q304,305			DTC143ZUA	DIGITAL TRANSISTOR	KR1K1
IC500			E-TDA7478AD	ANALOGUE IC	E2M1M2	Q304,305			DTC143ZUA	DIGITAL TRANSISTOR	K2
IC500			E-TDA7478AD	ANALOGUE IC	E3E4	Q403			DTC143ZUA	DIGITAL TRANSISTOR	E4K2
IC500			E-TDA7478AD	ANALOGUE IC	E5K1K2	Q403			DTC143ZUA	DIGITAL TRANSISTOR	E5R1K1
IC500			E-TDA7478AD	ANALOGUE IC	KR1E1	Q403			DTC143ZUA	DIGITAL TRANSISTOR	KM1M2
IC600			E-TDA7850A	ANALOGUE IC		Q403			DTC143ZUA	DIGITAL TRANSISTOR	X1E1E2
Q1			KTA1046-P	TRANSISTOR		Q406			TPC8110-F	FET	E4K2
Q2			DTA124EUA	DIGITAL TRANSISTOR		Q406			TPC8110-F	FET	E5R1K1
Q3			2SB1188 (R)	TRANSISTOR		Q406			TPC8110-F	FET	KM1M2
Q4			2SA1576A	TRANSISTOR		Q406			TPC8110-F	FET	X1E1E2
Q5			KTA1046-P	TRANSISTOR		Q407			DTA114YUA	DIGITAL TRANSISTOR	E4K2

E1: DDX5022 E2: DDX5022Y E3: DNX5220BT E4: DNX5220 E5: DDX52RY (Europe)

△Indicates safety critical components.

K: DDX512 K1: DNX5120 K2: DNX512EX (North America)

X1: DDX5032 (Australia) R1: DDX5032 (Latin America)

M1: DDX5032 M2: DDX5032M (Other Areas)

PARTS LIST

ELECTRIC UNIT (X34-575x-xx)

Ref. No.	Add	New	Parts No.	Description	Destination	Ref. No.	Add	New	Parts No.	Description	Destination
Q407			DTA114YUA	DIGITAL TRANSISTOR	E5R1K1	C105			CK73GB1H103K	CHIP C 0.010UF	K
Q407			DTA114YUA	DIGITAL TRANSISTOR	KM1M2	C107			CK73GB1H104K	CHIP C 0.10UF	K
Q407			DTA114YUA	DIGITAL TRANSISTOR	X1E1E2	C108			CK73DF1E106Z	CHIP C 10UF	Z
Q500			DTC144EUA	DIGITAL TRANSISTOR		C109			CK73GB1H103K	CHIP C 0.010UF	K
Q501			DTA144EUA	DIGITAL TRANSISTOR		C112			CK73FB1E154K	CHIP C 0.15UF	K
Q502			2SB1449 (R)-E	TRANSISTOR		C113			CK73GB1H104K	CHIP C 0.10UF	K
Q503			2SC4081	TRANSISTOR		C114			CC73GCH1H151J	CHIP C 150PF	J
Q504			DTC143ZUA	DIGITAL TRANSISTOR		C115,116			CK73GB1C224K	CHIP C 0.22UF	K
Q505			2SA1577	TRANSISTOR		C117			CC73GCH1H151J	CHIP C 150PF	J
Q700-702			DTC143ZUA	DIGITAL TRANSISTOR		C118			CK73EB1E225K	CHIP C 2.2UF	K
Q703			DTC143TUA	DIGITAL TRANSISTOR		C119			CE32AU1C220M	CHIP EL 22UF 16WV	
Q704			DTA144EUA	DIGITAL TRANSISTOR		C120			CK73GB1H103K	CHIP C 0.010UF	K
Q705,706			DTC143TUA	DIGITAL TRANSISTOR		C121			CK73FB1C105K	CHIP C 1.0UF	K
Q707			DTA144EUA	DIGITAL TRANSISTOR		C122-124			CK73EB1C106K	CHIP C 10UF	K
Q708,709			DTC143TUA	DIGITAL TRANSISTOR		C125			CK73GB1H103K	CHIP C 0.010UF	K
Q710			DTA144EUA	DIGITAL TRANSISTOR		C126,127			CK73GB1H104K	CHIP C 0.10UF	K
Q711			DTC143TUA	DIGITAL TRANSISTOR		C128			CK73EB1C106K	CHIP C 10UF	K
Q800			DTA144EUA	DIGITAL TRANSISTOR		C200			CK73GB1A105K	CHIP C 1.0UF	K
Q801			DTC144EUA	DIGITAL TRANSISTOR		C201			CK73FB0J106K	CHIP C 10UF	K
Q802			KTA1046-P	TRANSISTOR		C202			CK73GB1H104K	CHIP C 0.10UF	K
Q803			2SC4081	TRANSISTOR		C203			CK73GB1A105K	CHIP C 1.0UF	K
Q804			DTA124XUA	DIGITAL TRANSISTOR		C204			CK73FB0J106K	CHIP C 10UF	K
TH600			PRF18BE471QS2	POSITIVE RESISTOR		C205			CK73GB1H104K	CHIP C 0.10UF	K
A500			X86-4030-11	FRONT-END UNIT	KR1X1	C206			CK73EB1E225K	CHIP C 2.2UF	K
A500			X86-4030-11	FRONT-END UNIT	K1K2	C207,208			CC73GCH1H270J	CHIP C 27PF	J
A500			X86-4032-70	FRONT-END UNIT	E1E2M1	C210-218			CK73GB1H104K	CHIP C 0.10UF	K
A500			X86-4032-70	FRONT-END UNIT	E4	C219			CC73GCH1H560J	CHIP C 56PF	J
A500			X86-4032-70	FRONT-END UNIT	M2E5E3	C220			CK73FB0J106K	CHIP C 10UF	K
A501		*	X89-3062-70	DAUGHTER UNIT	E3E4	C221-224			CK73GB1H104K	CHIP C 0.10UF	K
VIDEO UNIT (X35-4890-10)						C225			CK73DF1E106Z	CHIP C 10UF	Z
D712,713		*	B30-3201-05	LED (RGB F3)		C226,227			CK73GB1H103K	CHIP C 0.010UF	K
D721			B30-1566-05	LED (1608,RED)		C228			CK73DF1E106Z	CHIP C 10UF	Z
D722			B30-1713-05	LED (SR,TS)		C229-246			CK73GB1H104K	CHIP C 0.10UF	K
D733			B30-1566-05	LED (1608,RED)		C247			CC73GCH1H101J	CHIP C 100PF	J
C1			CK73DF1E106Z	CHIP C 10UF	Z	C248			CK73GB1H103K	CHIP C 0.010UF	K
C2-5			CK73GB1H103K	CHIP C 0.010UF	K	C249-251			CK73GB1H104K	CHIP C 0.10UF	K
C6			CK73GB0J225K	CHIP C 2.2UF	K	C252			CK73GB1A105K	CHIP C 1.0UF	K
C7			CK73GB1E183K	CHIP C 0.018UF	K	C253			CK73GB1H102K	CHIP C 1000PF	K
C8			CK73GB0J225K	CHIP C 2.2UF	K	C254			CK73GB1H104K	CHIP C 0.10UF	K
C9			CK73GB1A474K	CHIP C 0.47UF	K	C255			CK73GB1A105K	CHIP C 1.0UF	K
C10			CK73GB1H152K	CHIP C 1500PF	K	C256,257			CK73GB1H104K	CHIP C 0.10UF	K
C11			CK73GB0J225K	CHIP C 2.2UF	K	C260			CC73GCH1H101J	CHIP C 100PF	J
C12			CK73GB1H103K	CHIP C 0.010UF	K	C261,262			CK73FB0J106K	CHIP C 10UF	K
C13,14			CK73GB1H473K	CHIP C 0.047UF	K	C263			CK73DF1E106Z	CHIP C 10UF	Z
C15			C93-1383-05	CHIP C 220PF	F	C264			CK73EB1E225K	CHIP C 2.2UF	K
C16,17			CK73DF1E106Z	CHIP C 10UF	Z	C266			CK73GB1H104K	CHIP C 0.10UF	K
C19-21			C93-1283-05	CHIP C 1.0UF	K	C267-270			CC73GCH1H101J	CHIP C 100PF	J
C22			C93-1270-05	CHIP C 3300PF	K	C271			CK73EB1E106K	CHIP C 10UF	K
C23			C93-1273-05	CHIP C 15PF	J	C272-275			CK73GB1H104K	CHIP C 0.10UF	K
C24			C93-1278-05	CHIP C 0.018UF	K	C276,277			CK73GB1A105K	CHIP C 1.0UF	K
C25			C93-1283-05	CHIP C 1.0UF	K	C278			CK73GB1H104K	CHIP C 0.10UF	K
C102			CK73EB0J226K	CHIP C 22UF	K	C279			CK73DF1E106Z	CHIP C 10UF	Z
C103			CK73FB0J106K	CHIP C 10UF	K	C405			CC73GCH1H330J	CHIP C 33PF	J
C104			CK73GB1H104K	CHIP C 0.10UF	K	C451			CC73GCH1H560J	CHIP C 56PF	J
						C458			CC73GCH1H102J	CHIP C 1000PF	J

E1: DDX5022 E2: DDX5022Y E3: DNX5220BT E4: DNX5220 E5: DDX52RY (Europe)

△ Indicates safety critical components.

K: DDX512 K1: DNX5120 K2: DNX512EX (North America)

X1: DDX5032 (Australia) R1: DDX5032 (Latin America)

M1: DDX5032 M2: DDX5032M (Other Areas)

PARTS LIST

VIDEO UNIT (X35-4890-10)

Ref. No.	Add	New	Parts No.	Description	Destination	Ref. No.	Add	New	Parts No.	Description	Destination
C459			CK73EB1C106K	CHIP C 10UF K		R16			RK73GB2A512J	CHIP R 5.1K J 1/10W	
C460			CK73GB1H103K	CHIP C 0.010UF K		R17			RK73GH2A563D	CHIP R 56K D 1/10W	
C462			CK73GB1H103K	CHIP C 0.010UF K		R18			RK73GH2A824D	CHIP R 820K D 1/10W	
C464			CK73GB1H103K	CHIP C 0.010UF K		R19-21			RK73GB2A220J	CHIP R 22 J 1/10W	
C466			CE32BJ1C220M	CHIP EL 22UF 16WV		R22			RK73GB2A512J	CHIP R 5.1K J 1/10W	
C467			CK73GB1H103K	CHIP C 0.010UF K		R23			RK73GB2A220J	CHIP R 22 J 1/10W	
C500			CK73FB0J106K	CHIP C 10UF K		R25			RK73GH2A471D	CHIP R 470 D 1/10W	
C501,502			CK73GB1H103K	CHIP C 0.010UF K		R26,27			RK73GB2A000J	CHIP R 0.0 J 1/10W	
C503			CK73GB1H104K	CHIP C 0.10UF K		R100			RK73GB2A000J	CHIP R 0.0 J 1/10W	
C504			CK73GB1A105K	CHIP C 1.0UF K		R102			RK73GB2A000J	CHIP R 0.0 J 1/10W	
C601			CK73GB1H104K	CHIP C 0.10UF K		R104			RK73GB2A562J	CHIP R 5.6K J 1/10W	
C608			CK73FB0J106K	CHIP C 10UF K		R107			RK73GH2A124D	CHIP R 120K D 1/10W	
C610,611			CK73GB1H102K	CHIP C 1000PF K		R108			RK73GH2A113D	CHIP R 11K D 1/10W	
C701			CK73EB0J226K	CHIP C 22UF K		R109			RK73GH2A104D	CHIP R 100K D 1/10W	
CN1		*	E41-2874-05	PIN ASSY		R110			RK73GH2A113D	CHIP R 11K D 1/10W	
CN3		*	E41-2979-05	FLAT CABLE CONNECTOR		R111			RK73GB2A473J	CHIP R 47K J 1/10W	
CN4			E41-2204-05	FLAT CABLE CONNECTOR		R112			RK73FB2B222J	CHIP R 2.2K J 1/8W	
CN5			E41-2088-05	FLAT CABLE CONNECTOR		R114			RK73GH2A513D	CHIP R 51K D 1/10W	
CN6		*	E41-2953-05	FLAT CABLE CONNECTOR		R115,116			RK73GB2A472J	CHIP R 4.7K J 1/10W	
CN7		*	E41-2301-05	FLAT CABLE CONNECTOR		R117			RK73GH2A113D	CHIP R 11K D 1/10W	
J1			E59-0854-05	RECTANGULAR PLUG		R201			RK73GB2A513J	CHIP R 51K J 1/10W	
J2			E11-1001-05	3.5D PHONE JACK		R203			RK73GB2A563J	CHIP R 56K J 1/10W	
F1			F53-0297-05	FUSE (UL,CSA) 1.6A		R204			RK73GB2A472J	CHIP R 4.7K J 1/10W	
F100			F53-0280-05	FUSE 0.63A		R205-207			RK73GB2A000J	CHIP R 0.0 J 1/10W	
						R208			RK73GH2A432D	CHIP R 4.3K D 1/10W	
L1			L19-0788-05	TRANSFORMER FOR CONVERTER		R210			RK73GB2A105J	CHIP R 1.0M J 1/10W	
L2			L33-2316-05	CHOKE COIL		R211			RK73GH2A222D	CHIP R 2.2K D 1/10W	
L100			L33-2316-05	CHOKE COIL		R212			RK73GH2A153D	CHIP R 15K D 1/10W	
L101			L41-4792-13	SMALL FIXED INDUCTOR (4.7UH)		R213			RK73GB2A000J	CHIP R 0.0 J 1/10W	
L102			L41-1005-33	SMALL FIXED INDUCTOR (10U)		R214,215			RK73GB2A101J	CHIP R 100 J 1/10W	
L103,104			L41-3392-13	SMALL FIXED INDUCTOR (3.3UH)		R216			RK73GB2A000J	CHIP R 0.0 J 1/10W	
L105,106			L41-1005-33	SMALL FIXED INDUCTOR (10U)		R217-221			RK73GB2A101J	CHIP R 100 J 1/10W	
L200,201			L41-1005-33	SMALL FIXED INDUCTOR (10U)		R222			RK73GB2A000J	CHIP R 0.0 J 1/10W	
L202-206			L92-0319-05	CHIP FERRITE		R223-225			RK73GB2A101J	CHIP R 100 J 1/10W	
L207			L41-1005-33	SMALL FIXED INDUCTOR (10U)		R226,227			RK73GB2A000J	CHIP R 0.0 J 1/10W	
L208			L41-8281-15	SMALL FIXED INDUCTOR (0.82U)		R228			RK73GB2A300J	CHIP R 30 J 1/10W	
L209-212			L92-0319-05	CHIP FERRITE		R231			RK73GB2A101J	CHIP R 100 J 1/10W	
L401			L41-2205-33	SMALL FIXED INDUCTOR (22U)		R233,234			RK73GB2A000J	CHIP R 0.0 J 1/10W	
L450			L41-1005-33	SMALL FIXED INDUCTOR (10U)		R235			RK73GB2A101J	CHIP R 100 J 1/10W	
L500			L41-1005-33	SMALL FIXED INDUCTOR (10U)		R237			RK73GB2A000J	CHIP R 0.0 J 1/10W	
L600			L92-0319-05	CHIP FERRITE		R240			RK73GB2A820J	CHIP R 82 J 1/10W	
X200			L77-2965-05	CRYSTAL RESONATOR (12.000MHZ)		R241,242			RK73FB2B470J	CHIP R 47 J 1/8W	
R1			RK73FB2B152J	CHIP R 1.5K J 1/8W		R243			RK73GB2A473J	CHIP R 47K J 1/10W	
R4			RK73GB2A153J	CHIP R 15K J 1/10W		R244-246			RK73GB2A101J	CHIP R 100 J 1/10W	
R5			RK73GB2A220J	CHIP R 22 J 1/10W		R248			RK73GB2A473J	CHIP R 47K J 1/10W	
R6			RK73GB2A222J	CHIP R 2.2K J 1/10W							
R7			RK73GH2A433D	CHIP R 43K D 1/10W		R251			RK73GB2A103J	CHIP R 10K J 1/10W	
R9			RK73GB2A220J	CHIP R 22 J 1/10W		R253-259			RK73GB2A101J	CHIP R 100 J 1/10W	
R10			RK73GB2A515J	CHIP R 5.1M J 1/10W		R260			RK73GH2A513D	CHIP R 51K D 1/10W	
R11			RK73GH2A513D	CHIP R 51K D 1/10W		R261			RK73GH2A433D	CHIP R 43K D 1/10W	
R12			RK73GB2A101J	CHIP R 100 J 1/10W		R262			RK73GB2A000J	CHIP R 0.0 J 1/10W	
R13			RK73GB2A104J	CHIP R 100K J 1/10W							
R14			RK73GH2A204D	CHIP R 200K D 1/10W		R263			RK73GB2A103J	CHIP R 10K J 1/10W	
R15			RK73GB2A105J	CHIP R 1.0M J 1/10W		R264-266			RK73GB2A000J	CHIP R 0.0 J 1/10W	
						R267			RK73GB2A103J	CHIP R 10K J 1/10W	
						R268			RK73GB2A102J	CHIP R 1.0K J 1/10W	
						R269			RK73GB2A101J	CHIP R 100 J 1/10W	

PARTS LIST

VIDEO UNIT (X35-4890-10)

Ref. No.	Add	New	Parts No.	Description	Destination	Ref. No.	Add	New	Parts No.	Description	Destination
R270			RK73GB2A472J	CHIP R 4.7K J 1/10W		S600			S70-0901-05	TACT SWITCH	
R271,272			RK73GB2A000J	CHIP R 0.0 J 1/10W		S701-704			S70-0901-05	TACT SWITCH	
R273			RK73FB2B472J	CHIP R 4.7K J 1/8W		S601	*		T99-0482-05	ROTARY ENCODER	
R274-277			RK73GB2A473J	CHIP R 47K J 1/10W		D1			UDZS5.6B	ZENER DIODE	
R278,279			RK73GB2A101J	CHIP R 100 J 1/10W		D2,3			1SS355	DIODE	
R280-283			RK73GB2A103J	CHIP R 10K J 1/10W		D4			UDZS5.6B	ZENER DIODE	
R400			RK73GB2A000J	CHIP R 0.0 J 1/10W		D5			MA2S784-F	DIODE	
R401			RK73GB2A272J	CHIP R 2.7K J 1/10W		D6			UDZS5.6B	ZENER DIODE	
R402			RK73GB2A101J	CHIP R 100 J 1/10W		D7,8			DA204U	DIODE	
R406			RK73GB2A203J	CHIP R 20K J 1/10W		D9			CVS10A120M	VARIATOR	
R407			RK73GB2A272J	CHIP R 2.7K J 1/10W		D100			EP05Q06	DIODE	
R408			RK73GB2A102J	CHIP R 1.0K J 1/10W		D101-103			EP05Q04	DIODE	
R410			RK73GB2A203J	CHIP R 20K J 1/10W		D201,202			CVL10C270M300	VARIATOR	
R458			RK73GH2A202D	CHIP R 2.0K D 1/10W		D500-503			UDZS6.2B	ZENER DIODE	
R459			RK73GH2A182D	CHIP R 1.8K D 1/10W		D601-606			CVS10A180M	VARIATOR	
R460			RK73GB2A222J	CHIP R 2.2K J 1/10W		D608-611			CVS10A180M	VARIATOR	
R461			RK73GH2A473D	CHIP R 47K D 1/10W		D612			DA204U	DIODE	
R462			RK73GH2A333D	CHIP R 33K D 1/10W		D613			CVL10C270M300	VARIATOR	
R464			RK73GB2A103J	CHIP R 10K J 1/10W		D700			UDZS6.2B	ZENER DIODE	
R470			RK73GB2A103J	CHIP R 10K J 1/10W		D709-711			CVS10A180M	VARIATOR	
R476			RK73GB2A103J	CHIP R 10K J 1/10W		D714-716			CVS10A180M	VARIATOR	
R500,501			RK73GB2A333J	CHIP R 33K J 1/10W		D719			CVS10A180M	VARIATOR	
R502-505			RK73EB2E100J	CHIP R 10 J 1/4W		D725			CVS10A180M	VARIATOR	
R600,601			RK73GB2A103J	CHIP R 10K J 1/10W		D734			CVS10A180M	VARIATOR	
R602,603			RK73EB2E100J	CHIP R 10 J 1/4W		IC1			OZ964ISN-C-SN	ANALOGUE IC	
R604,605			RK73GB2A103J	CHIP R 10K J 1/10W		IC101	*		74AHC1G04GW	MOS-IC	
R608			RK73GB2A272J	CHIP R 2.7K J 1/10W		IC102			LT1947-PBF	ANALOGUE IC	
R609,610			RK73GB2A303J	CHIP R 30K J 1/10W		IC200			S-1112B25MCG	ANALOGUE IC	
R611,612			RK73GB2A103J	CHIP R 10K J 1/10W		IC201			TA75W558FU-F	ANALOGUE IC	
R613			RK73GB2A750J	CHIP R 75 J 1/10W		IC202			TC7WH74FU-F	MOS-IC	
R614			RK73GB2A102J	CHIP R 1.0K J 1/10W		IC203			MST7988LA-ALF	MOS-IC	
R615,616			RK73GB2A103J	CHIP R 10K J 1/10W		IC204			74AHC1G32GW	MOS-IC	
R617			RK73EB2E100J	CHIP R 10 J 1/4W		IC205	*		XC6201P532MR	ANALOGUE IC	
R618			RK73GB2A103J	CHIP R 10K J 1/10W		IC206	*		74LVC3G34DP	MOS-IC	
R619			RK73EB2E100J	CHIP R 10 J 1/4W		IC207	*		AT25F2048	ROM IC	
R620			RK73GB2A102J	CHIP R 1.0K J 1/10W		IC208			XC6201P502MR	ANALOGUE IC	
R621			RK73EB2E100J	CHIP R 10 J 1/4W		IC501	*		74AHCT1G08GW	MOS-IC	
R622			RK73GB2A103J	CHIP R 10K J 1/10W		IC700			PIC95603	ANALOGUE IC	
R623-628			RK73EB2E100J	CHIP R 10 J 1/4W		Q1,2			2SC4081	TRANSISTOR	
R629			RK73GB2A682J	CHIP R 6.8K J 1/10W		Q3			DTC143ZUA	DIGITAL TRANSISTOR	
R630			RK73EB2E100J	CHIP R 10 J 1/4W		Q4,5			SI5504DC-E3	DUAL FET	
R632			RK73GB2A100J	CHIP R 10 J 1/10W		Q100			2SC4081	TRANSISTOR	
R633			RK73EB2E101J	CHIP R 100 J 1/4W		Q101			2SA1576A	TRANSISTOR	
R700			RK73FB2B101J	CHIP R 100 J 1/8W		Q201			2SC4097	TRANSISTOR	
R701			RK73GB2A221J	CHIP R 220 J 1/10W		Q202			2SA1577	TRANSISTOR	
R706			RK73GB2A183J	CHIP R 18K J 1/10W		Q400,401			2SA1576A	TRANSISTOR	
R707			RK73GH2A471D	CHIP R 470 D 1/10W		Q450			DTC123JUA	DIGITAL TRANSISTOR	
R708		*	RK73GH2A511D	CHIP R 510 D 1/10W		Q451			UMZ1N	TRANSISTOR	
R709			RK73GH2A361D	CHIP R 360 D 1/10W		Q500,501			DTC123JUA	DIGITAL TRANSISTOR	
R710			RK73GB2A681J	CHIP R 680 J 1/10W		Q502			DTA123JUA	DIGITAL TRANSISTOR	
R711			RK73GH2A201D	CHIP R 200 D 1/10W		Q503			DTC143ZUA	DIGITAL TRANSISTOR	
R712			RK73GH2A561D	CHIP R 560 D 1/10W		Q504			DTA123JUA	DIGITAL TRANSISTOR	
R713			RK73GH2A201D	CHIP R 200 D 1/10W		Q600-604			2SC4081	TRANSISTOR	
R716			RK73GB2A151J	CHIP R 150 J 1/10W							
VR200		*	R32-0350-05	SEMI FIXED VARIABLE RESISTOR							

PARTS LIST

VIDEO UNIT (X35-4890-10)

Ref. No.	Add	New	Parts No.	Description	Destination
Q606			DTA144EUA	DIGITAL TRANSISTOR	
DVD UNIT (X37-1100-03)					
C3			CK73HB1A104K	CHIP C 0.10UF K	
C4			CC73HCH1H471J	CHIP C 470PF J	
C5-7			CK73HB1E103K	CHIP C 0.010UF K	
C8			CC73HCH1H471J	CHIP C 470PF J	
C9			CK73HB0J105K	CHIP C 1.0UF K	
C10			CK73GB0J475K	CHIP C 4.7UF K	
C11,12			CK73HB1E103K	CHIP C 0.010UF K	
C13			CK73HB1H472K	CHIP C 4700PF K	
C14			CK73GB0J106M	CHIP C 10UF M	
C15			CK73HB1A104K	CHIP C 0.10UF K	
C16			CK73GB0J106M	CHIP C 10UF M	
C17			CK73GB0J475K	CHIP C 4.7UF K	
C18			CK73FB0J226M	CHIP C 22UF M	
C21			CK73GB0J106M	CHIP C 10UF M	
C22,23			CK73GB0J475K	CHIP C 4.7UF K	
C50			CK73HB1E103K	CHIP C 0.010UF K	
C51			CK73HB1A104K	CHIP C 0.10UF K	
C52			CK73HB1E223K	CHIP C 0.022UF K	
C53			CC73HCH1H470J	CHIP C 47PF J	
C54			CC73HCH1H102J	CHIP C 1000PF J	
C55			CC73HCH1H100D	CHIP C 10PF D	
C56			CC73HCH1H102J	CHIP C 1000PF J	
C57			CC73HCH1E681J	CHIP C 680PF J	
C58			CK73HB1H682K	CHIP C 6800PF K	
C60,61			CK73HB1A104K	CHIP C 0.10UF K	
C62			CC73HCH1H102J	CHIP C 1000PF J	
C63			CC73HCH1H331J	CHIP C 330PF J	
C64			CK73HB1H222K	CHIP C 2200PF K	
C65			CC73HCH1E681J	CHIP C 680PF J	
C66			CK73HB1H152K	CHIP C 1500PF K	
C67,68			CC73HCH1H102J	CHIP C 1000PF J	
C69-72			CC73HCH1H151J	CHIP C 150PF J	
C73-82			CK73HB1A104K	CHIP C 0.10UF K	
C83			C93-1228-05	CHIP C 1UF M	
C84			CK73HB0J105K	CHIP C 1.0UF K	
C85			CK73HB1A104K	CHIP C 0.10UF K	
C86			C93-1228-05	CHIP C 1UF M	
C90			CK73HB1E103K	CHIP C 0.010UF K	
C92			C93-1228-05	CHIP C 1UF M	
C93-95			CK73HB1A104K	CHIP C 0.10UF K	
C97			CK73HB1A104K	CHIP C 0.10UF K	
C99			CK73HB1A104K	CHIP C 0.10UF K	
C100			CK73FB0J226M	CHIP C 22UF M	
C101			CK73GB0J475K	CHIP C 4.7UF K	
C103,104			CK73FB0J226M	CHIP C 22UF M	
C120,121			CK73HB1E223K	CHIP C 0.022UF K	
C143,144			CC73HCH1H120J	CHIP C 12PF J	
C202			CK73FB0J226M	CHIP C 22UF M	
C207,208			CK73HB1A104K	CHIP C 0.10UF K	
C210			CK73HB1A104K	CHIP C 0.10UF K	
C212			CK73HB1A104K	CHIP C 0.10UF K	
C213			CK73HB1H332K	CHIP C 3300PF K	

Ref. No.	Add	New	Parts No.	Description	Destination
C214,215			CK73HB1A104K	CHIP C 0.10UF K	
C216			CC73HCH1H471J	CHIP C 470PF J	
C217			CK73HB1A104K	CHIP C 0.10UF K	
C218			CK73HB1C473K	CHIP C 0.047UF K	
C219-224			CK73HB1A104K	CHIP C 0.10UF K	
C225			CK73GB0J475K	CHIP C 4.7UF K	
C227			CK73FB0J226M	CHIP C 22UF M	
C434			CK73GB0J106M	CHIP C 10UF M	
C435			CK73HB1E103K	CHIP C 0.010UF K	
C436,437			CK73HB1A104K	CHIP C 0.10UF K	
C440-442			CK73FB0J226M	CHIP C 22UF M	
C444			CC73HCH1H102J	CHIP C 1000PF J	
C445			CK73HB1E103K	CHIP C 0.010UF K	
C446			CC73HCH1H101J	CHIP C 100PF J	
C447,448			CC73HCH1H102J	CHIP C 1000PF J	
C449,450			CK73HB1H472K	CHIP C 4700PF K	
C451			CC73HCH1H102J	CHIP C 1000PF J	
CN1			E41-2594-05	FLAT CABLE CONNECTOR	
CN2			E41-2603-05	FLAT CABLE CONNECTOR	
CN3			E41-2596-05	FLAT CABLE CONNECTOR	
P2			E23-0766-05	TERMINAL	
P8			E23-0766-05	TERMINAL	
L1			L92-0365-05	CHIP FERRITE	
L5			L92-0365-05	CHIP FERRITE	
L6			L92-0617-05	CHIP FERRITE	
X1			L77-2870-05	CRYSTAL RESONATOR	
CP2-4			RK74HB1J103J	CHIP-COM 10K J 1/16W	
CP5-9			RK74HB1J330J	CHIP-COM 33 J 1/16W	
CP10			RK74HB1J820J	CHIP-COM 82 J 1/16W	
CP11			RK74HB1J103J	CHIP-COM 10K J 1/16W	
R1			RK73HB1J103J	CHIP R 10K J 1/16W	
R3,4			RK73HB1J103J	CHIP R 10K J 1/16W	
R5,6			RK73HH1J123D	CHIP R 12K D 1/16W	
R7			RK73HH1J333D	CHIP R 33K D 1/16W	
R8,9			RK73HB1J103J	CHIP R 10K J 1/16W	
R10			RK73HB1J163J	CHIP R 16K J 1/16W	
R11			RK73HB1J102J	CHIP R 1.0K J 1/16W	
R13			RK73HB1J103J	CHIP R 10K J 1/16W	
R16			RK73HB1J103J	CHIP R 10K J 1/16W	
R17			RK73HB1J271J	CHIP R 270 J 1/16W	
R18			RK73HH1J270D	CHIP R 27 D 1/16W	
R19			RK73HB1J301J	CHIP R 300 J 1/16W	
R21,22			RK73HH1J103D	CHIP R 10K D 1/16W	
R26,27			R92-5146-05	CHIP R 1.0 D 1/4W	
R28,29			R92-5147-05	CHIP R 1.2 D 1/4W	
R31			RK73HB1J102J	CHIP R 1.0K J 1/16W	
R50,51			RK73HB1J510J	CHIP R 51 J 1/16W	
R52			RK73HH1J153D	CHIP R 15K D 1/16W	
R53			RK73HB1J105J	CHIP R 1.0M J 1/16W	
R54			RK73HB1J472J	CHIP R 4.7K J 1/16W	
R55			RK73HB1J103J	CHIP R 10K J 1/16W	
R56			RK73HH1J472D	CHIP R 4.7K D 1/16W	
R57,58			RK73HB1J202J	CHIP R 2.0K J 1/16W	
R59,60			RK73HB1J103J	CHIP R 10K J 1/16W	

PARTS LIST

DVD UNIT (X37-1100-03)

Ref. No.	Add	New	Parts No.	Description	Destination
R63			RK73HB1J103J	CHIP R 10K J 1/16W	
R64,65			RK73HB1J472J	CHIP R 4.7K J 1/16W	
R81			RK73HB1J103J	CHIP R 10K J 1/16W	
R83,84			RK73HB1J473J	CHIP R 47K J 1/16W	
R85			RK73HB1J223J	CHIP R 22K J 1/16W	
R86			RK73HB1J103J	CHIP R 10K J 1/16W	
R87			RK73HB1J105J	CHIP R 1.0M J 1/16W	
R88			RK73HB1J152J	CHIP R 1.5K J 1/16W	
R89,90			RK73HB1J123J	CHIP R 12K J 1/16W	
R91			RK73HB1J472J	CHIP R 4.7K J 1/16W	
R92			RK73HB1J273J	CHIP R 27K J 1/16W	
R96			RK73HB1J103J	CHIP R 10K J 1/16W	
R98			RK73HB1J202J	CHIP R 2.0K J 1/16W	
R101			RK73HH1J273D	CHIP R 27K D 1/16W	
R102			RK73GB2A470J	CHIP R 47 J 1/10W	
R105			RK73HB1J103J	CHIP R 10K J 1/16W	
R113			RK73HB1J153J	CHIP R 15K J 1/16W	
R120			RK73HB1J103J	CHIP R 10K J 1/16W	
R121			RK73HB1J820J	CHIP R 82 J 1/16W	
R122			RK73HB1J103J	CHIP R 10K J 1/16W	
R123			RK73HB1J330J	CHIP R 33 J 1/16W	
R124-126			RK73HB1J820J	CHIP R 82 J 1/16W	
R150,151			RK73HB1J102J	CHIP R 1.0K J 1/16W	
R152,153			RK73HB1J104J	CHIP R 100K J 1/16W	
R154,155			RK73HB1J103J	CHIP R 10K J 1/16W	
R158,159			RK73HB1J1R0J	CHIP R 1.0 J 1/16W	
R160			R92-3350-05	CHIP R 2.2 F 1/10W	
R162,163			RK73HB1J104J	CHIP R 100K J 1/16W	
R164,165			RK73HH1J101D	CHIP R 100 D 1/16W	
R166			RK73HB1J225J	CHIP R 2.2M J 1/16W	
R167			RK73HH1J113D	CHIP R 11K D 1/16W	
R168			RK73HH1J273D	CHIP R 27K D 1/16W	
R169			RK73HB1J125J	CHIP R 1.2M J 1/16W	
R255			R92-5112-05	CHIP R 4.7 F 1/10W	
R256			RK73HH1J111D	CHIP R 110 D 1/16W	
R257			RK73HH1J202D	CHIP R 2.0K D 1/16W	
R258,259			RK73HB1J103J	CHIP R 10K J 1/16W	
R260			RK73HH1J132D	CHIP R 1.3K D 1/16W	
R261			RK73HH1J203D	CHIP R 20K D 1/16W	
R262			RK73HB1J821J	CHIP R 820 J 1/16W	
R263			RK73HB1J242J	CHIP R 2.4K J 1/16W	
R265-268			RK73HB1J000J	CHIP R 0.0 J 1/16W	
R270			RK73HB1J000J	CHIP R 0.0 J 1/16W	
R271			RK73HB1J471J	CHIP R 470 J 1/16W	
R272			RK73HH1J682D	CHIP R 6.8K D 1/16W	
R273			RK73HH1J122D	CHIP R 1.2K D 1/16W	
R274			RK73HH1J682D	CHIP R 6.8K D 1/16W	
R275			RK73HH1J122D	CHIP R 1.2K D 1/16W	
R278			R92-5112-05	CHIP R 4.7 F 1/10W	
R279			RK73HH1J102D	CHIP R 1.0K D 1/16W	
R280			RK73HB1J4R7J	CHIP R 4.7 J 1/16W	
R284			RK73HB1J000J	CHIP R 0.0 J 1/16W	
R285-287			RK73GB2A000J	CHIP R 0.0 J 1/10W	
S1			S68-0911-15	PUSH SWITCH	

Ref. No.	Add	New	Parts No.	Description	Destination
S2			S68-0914-05	PUSH SWITCH	
D1			1SS402-F	DIODE	
D5,6			015AZ5.1-F (Y)	ZENER DIODE	
D8			1SS387-F	DIODE	
IC1			AN22022ABV	ANALOGUE IC	
IC3			-	ROM IC	
IC4			MN103S71F	MOS-IC	
IC5			S1000N2814T1G	ANALOGUE IC	
IC7			TA48S033AF-Q	ANALOGUE IC	
IC8			S-80812CNP-F	ANALOGUE IC	
IC9			TA48S015AF-Q	ANALOGUE IC	
IC10			AN41250A-VB	ANALOGUE IC	
IC11			-	ROM IC	
IC12			NJU7042	ANALOGUE IC	
Q1-4			DTA143XE	TRANSISTOR	
Q5,6			2SK3019	FET	
Q12,13			2SB1709	TRANSISTOR	
Q14			SSM3J15FU-F	FET	
Q15			DTA143ZE	TRANSISTOR	
Q18			DTA143ZE	TRANSISTOR	
Q19			DTC114EE	TRANSISTOR	
DAUGHTER UNIT (X89-3062-70)					
C1			CC73GCH1H180J	CHIP C 18PF J	E3E4
C2			CC73GCH1H070D	CHIP C 7.0PF D	E3E4
C3			CC73GCH1H150J	CHIP C 15PF J	E3E4
C4			CC73GCH1H180J	CHIP C 18PF J	E3E4
C5			CC73GCH1H390J	CHIP C 39PF J	E3E4
C6			CC73GCH1H020C	CHIP C 2.0PF C	E3E4
C7			CC73GCH1H120J	CHIP C 12PF J	E3E4
C8			CK73FB1C105K	CHIP C 1.0UF K	E3E4
C10-12			CC73GCH1H102J	CHIP C 1000PF J	E3E4
C13			CC73GCH1H221J	CHIP C 220PF J	E3E4
C14			CC73GCH1H030C	CHIP C 3.0PF C	E3E4
C15,16			CC73GCH1H560J	CHIP C 56PF J	E3E4
C17			CC73GCH1H102J	CHIP C 1000PF J	E3E4
CN1		*	E41-3008-05	PIN ASSY	E3E4
W1		*	E30-6808-05	CORD WITH PLUG (ANT)	E3E4
W2		*	E30-6807-05	CORD WITH PLUG	E3E4
L1			L41-2705-33	SMALL FIXED INDUCTOR (27U)	E3E4
L2			L41-1588-18	SMALL FIXED INDUCTOR	E3E4
L3			L41-1805-33	SMALL FIXED INDUCTOR (18U)	E3E4
L4,5			L41-1588-18	SMALL FIXED INDUCTOR	E3E4
L6			L19-0825-05	BALUN TRANSFORMER	E3E4
L8			L41-1888-18	SMALL FIXED INDUCTOR (0.18U)	E3E4
R1			RK73GB2A104J	CHIP R 100K J 1/10W	E3E4
R3			RK73GB2A562J	CHIP R 5.6K J 1/10W	E3E4
R4			RK73GB2A332J	CHIP R 3.3K J 1/10W	E3E4
R5			RK73GB2A331J	CHIP R 330 J 1/10W	E3E4
R6			RK73GB2A391J	CHIP R 390 J 1/10W	E3E4
R7,8			RK73GB2A330J	CHIP R 33 J 1/10W	E3E4
R10			RK73GB2A431J	CHIP R 430 J 1/10W	E3E4
R11			RK73GB2A270J	CHIP R 27 J 1/10W	E3E4
R12			RK73GB2A431J	CHIP R 430 J 1/10W	E3E4

E1: DDX5022 E2: DDX5022Y E3: DNX5220BT E4: DNX5220 E5: DDX52RY (Europe)
 K: DDX512 K1: DNX5120 K2: DNX512EX (North America)
 X1: DDX5032 (Australia) R1: DDX5032 (Latin America)
 M1: DDX5032 M2: DDX5032M (Other Areas)

The IC3, and IC11 in the DVD unit (X37-1100-03) are not replaceable components. When these ICs are defective, replace the whole DVD mechanism assembly (X92-6160-00).

PARTS LIST

DAUGHTER UNIT (X89-3062-70)

Ref. No.	A d d	N e w	Parts No.	Description	Desti- nation
R13			RK73GB2A151J	CHIP R 150 J 1/10W	E3E4
R14			RK73GB2A431J	CHIP R 430 J 1/10W	E3E4
R15			RK73GB2A270J	CHIP R 27 J 1/10W	E3E4
R17			RK73GB2A431J	CHIP R 430 J 1/10W	E3E4
D1			IMSA-6801-E	SURGE ABSORBER	E3E4
Q1			2SC3357-A	TRANSISTOR	E3E4
DVD MECHANISM ASSY (X92-6160-00) (DVS-8020V)					
1	1A		A10-5331-51	CHASSIS	
2	2B		A10-5332-51	CHASSIS	
3	1A		A10-5333-31	CHASSIS	
4	3A	*	A10-5460-02	CHASSIS	
7	1B		D10-4918-22	ARM	
8	1B		D10-4919-22	ARM	
9	1B		D10-4920-02	LEVER	
10	1B		D10-4921-02	LEVER	
12	2B		D10-4922-12	SLIDER	
13	2A	*	D10-7011-02	ARM	
14	2B		D10-4924-13	ARM	
15	2B		D10-4925-12	ARM	
25	2B	*	D10-4973-04	SLIDER ASSY	
27	2A		D10-4945-04	LEVER	
28	2B		D12-0639-02	CAM	
31	2B		D13-2402-04	GEAR	
32	2B		D13-2403-04	GEAR	
33	2B		D13-2404-04	GEAR	
34	2B		D13-2405-04	GEAR	
35	2B		D13-2406-04	GEAR	
36	2B		D13-2407-04	GEAR	
40	2A		D13-2413-04	GEAR	
41	2A		D13-2415-04	GEAR	
42	2A		D13-2416-04	GEAR	
43	1B		D14-1013-14	ROLLER	
53	1B		D21-2487-24	SHAFT	
54	2A	*	D39-0275-05	DAMPER	
55	2A	*	D39-0276-05	DAMPER	
60	3A		F09-2825-23	SHEET	
65	2B		G01-3298-04	EXTENSION SPRING	
66	1B		G01-3299-04	EXTENSION SPRING	
67	2A		G01-3300-14	TORSION COIL SPRING	
68	2B		G01-4601-04	EXTENSION SPRING	
69	1B		G01-4602-04	EXTENSION SPRING	
70	1B		G01-4604-04	TORSION COIL SPRING	
74	2B		G01-4609-14	TORSION COIL SPRING	
75	1B	*	G02-1564-03	FLAT SPRING	
79	2A	*	J22-0475-21	MOUNTING HARDWARE	
80	3B	*	J22-0636-01	MOUNTING HARDWARE	
A	1A		N09-6382-05	MACHINE SCREW (M1.7X2.0)	
B	3B		N09-6408-15	TAPTITE SCREW (1.7X4 P-TITE)	
C	1B		N09-6426-15	MACHINE SCREW (LOAD ARM SCREW)	
D	3A		N09-6104-05	MACHINE SCREW (2X10 S-TITE)	
93	2A		T99-0471-05	MAGNET	

Ref. No.	A d d	N e w	Parts No.	Description	Desti- nation
96	1B		X94-2080-00	ROLLER ASSY	
98	2A		X94-2060-00	TRAVERSE ASSY (PICKUP,SPINDLE)	
VM1	2A		X94-2070-00	MOTOR ASSY (LOADING)	

E1: DDX5022 E2: DDX5022Y E3: DNX5220BT E4: DNX5220 E5: DDX52RY (Europe) Δ Indicates safety critical components.

K: DDX512 K1: DNX5120 K2: DNX512EX (North America)

X1: DDX5032 (Australia) R1: DDX5032 (Latin America)

M1: DDX5032 M2: DDX5032M (Other Areas)

PARTS LIST

CAPACITORS

$\frac{CC}{1} \frac{45}{2} \frac{TH}{3} \frac{1H}{4} \frac{220}{5} \frac{J}{6}$

- 1 = Type ... ceramic, electrolytic, etc.
- 2 = Shape ... round, square, etc.
- 3 = Temp. coefficient
- 4 = Voltage rating
- 5 = Value
- 6 = Tolerance

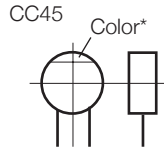

Capacitor value

- 010 = 1pF
- 100 = 10pF
- 101 = 100pF
- 102 = 1000pF = 0.001μF
- 103 = 0.01μF

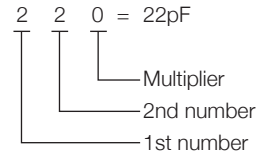

Temperature coefficient

1st Word	C	L	P	R	S	T	U
Color*	Black	Red	Orange	Yellow	Green	Blue	Violet
ppm/°C	0	-80	-150	-220	-330	-470	-750

2nd Word	G	H	J	K	L
ppm/°C	±30	±60	±120	±250	±500

Example : CC45TH = -470±60ppm/°C

Tolerance (More than 10pF)

Code	C	D	G	J	K	M	X	Z	P	No code
(%)	±0.25	±0.5	±2	±5	±10	±20	+40 -20	+80 -20	+100 -0	More than 10μF : -10~+50 Less than 4.7μF : -10~+75

(Less than 10pF)

Code	B	C	D	F	G
(pF)	±0.1	±0.25	±0.5	±1	±2

Voltage rating

2nd word \ 1st word	A	B	C	D	E	F	G	H	J	K	V
0	1.0	1.25	1.6	2.0	2.5	3.15	4.0	5.0	6.3	8.0	-
1	10	12.5	16	20	25	31.5	40	50	63	80	35
2	100	125	160	200	250	315	400	500	630	800	-
3	1000	1250	1600	2000	2500	2150	4000	5000	6300	8000	-

Chip capacitors

- (EX) $\frac{CC}{1} \frac{73}{2} \frac{F}{3} \frac{SL}{4} \frac{1H}{5} \frac{000}{6} \frac{J}{7}$ → Refer to the table above.
- (Chip) (CH, RH, UJ, SL)
- (EX) $\frac{CK}{1} \frac{73}{2} \frac{F}{3} \frac{F}{4} \frac{1H}{5} \frac{000}{6} \frac{Z}{7}$ →
- (Chip) (B, F)
- 1 = Type
 - 2 = Shape
 - 3 = Dimension
 - 4 = Temp. coefficient
 - 5 = Voltage rating
 - 6 = Value
 - 7 = Tolerance

Dimension

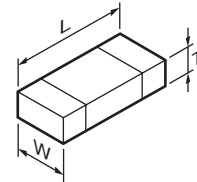

Chip capacitor

Code	L	W	T
Empty	5.6±0.5	5.0±0.5	Less than 2.0
A	4.5±0.5	3.2±0.4	Less than 2.0
B	4.5±0.5	2.0±0.3	Less than 2.0
C	4.5±0.5	1.25±0.2	Less than 1.25
D	3.2±0.4	2.5±0.3	Less than 1.5
E	3.2±0.2	1.6±0.2	Less than 1.25
F	2.0±0.3	1.25±0.2	Less than 1.25
G	1.6±0.2	0.8±0.2	Less than 1.0
H	1.0±0.05	0.5±0.05	0.5±0.05

Chip resistor

Code	L	W	T
E	3.2±0.2	1.6±0.2	1.0
F	2.0±0.3	1.25±0.2	1.0
G	1.6±0.2	0.8±0.2	0.5±0.1
H	1.0±0.05	0.5±0.05	0.35±0.05

RESISTORS

Chip resistor (Carbon)

- (EX) $\frac{RD}{1} \frac{73}{2} \frac{E}{3} \frac{B}{4} \frac{2B}{5} \frac{000}{6} \frac{J}{7}$
- (Chip) (B, F)

Carbon resistor (Normal type)

- (EX) $\frac{RD}{1} \frac{14}{2} \frac{B}{3} \frac{B}{4} \frac{2C}{5} \frac{000}{6} \frac{J}{7}$

- 1 = Type
- 2 = Shape
- 3 = Dimension
- 4 = Temp. coefficient
- 5 = Rating wattage
- 6 = Value
- 7 = Tolerance

Rating wattage

Code	Wattage	Code	Wattage	Code	Wattage
1J	1/16W	2C	1/6W	3A	1W
2A	1/10W	2E	1/4W	3D	2W
2B	1/8W	2H	1/2W		

SPECIFICATIONS (DNX5220BT/5220, DDX5022/5022Y/52RY)**Monitor section**

Picture Size	6.1 inches (diagonal) wide
.....	136.08 mm (W) x 71.96 mm (H)
Display System.....	Transparent TN LCD panel
Drive System	TFT active matrix system
Number of Pixels	336,960 (480H x 234V x RGB)
Effective Pixels	99.99 %
Pixel Arrangement	RGB striped arrangement
Back Lighting	Cold Cathode Fluorescent Tube

DVD player section

D/A Converter.....	24 bit
Audio Decoder ...Linear PCM/ Dolby Digital/ dts/ MP3/ WMA/ AAC	
Video Decoder.....	MPEG1/ MPEG2/ MPEG4 (Divx)
Wow & Flutter	Below Measurable Limit
Frequency Response	
Sampling frequency	96 kHz : 20 – 44,000 Hz
Sampling frequency	48 kHz : 20 – 22,000 Hz
Sampling frequency	44.1 kHz : 20 – 20,000 Hz
Total Harmonic Distortion.....	0.010 % (1 kHz)
S/N Ratio (dB).....	98 dB (DVD-Video 96 kHz)
Dynamic Range	98 dB (DVD-Video 96 kHz)
Disc Format	DVD-Video/ VIDEO-CD/ CD-DA
Sampling Frequency	44.1/ 48/ 96 kHz
Quantifying Bit Number	16/ 20/ 24 bit

USB interface section

USB Standard	USB 1.1/ 2.0
File System	FAT 16/ 32
Maximum Power Supply Current	500 mA
D/A Converter.....	24 Bit
Audio Decoder	MP3/ WMA/ AAC
Video Decoder.....	MPEG1/ MPEG2/ MPEG4 (Divx)

FM tuner section

Frequency Range (50 kHz)	87.5 MHz – 108.0 MHz
Usable Sensitivity (S/N : 26 dB)	0.7 μ V/ 75 Ω
Quieting Sensitivity (S/N : 46 dB)	1.6 μ V/ 75 Ω
Frequency Response (\pm 3.0 dB).....	30 Hz – 15 kHz
S/N Ratio (dB).....	65 dB (MONO)
Selectivity (\pm 400 kHz).....	\geq 80 dB
Stereo Separation.....	35 dB (1 kHz)

LW tuner section

Frequency Range (9 kHz)	153 kHz – 281 kHz
Usable Sensitivity	45 μ V

MW tuner section

Frequency Range (9 kHz)	531 kHz – 1611 kHz
Usable Sensitivity	25 μ V

Video section

Color System of External Video Input	NTSC/PAL
External Video Input Level (mini jack).....	1 Vp-p/ 75 Ω
External Audio Max Input Level (mini jack)	2 V/ 25 k Ω

Video Output Level (RCA jacks)	1 Vp-p/ 75 Ω
Audio Output Level (RCA jacks).....	1.2 V/ 10 k Ω
Analog RGB input (DDX5022/DDX5022Y/DDX52RY only)	
.....	0.7 Vp-p/ 75 Ω

Audio section

Maximum Power (Front & Rear)	50 W x 4
Full Bandwidth Power (Front & Rear)	
(PWR DIN 45324, +B=14.4V).....	30 W x 4
Preout Level (V)	2 V/ 10 k Ω
Preout Impedance	600 Ω
Speaker Impedance	4 – 8 Ω
Tone action	
Bass	100 Hz \pm 10 dB
Middle	1 kHz \pm 10 dB
Treble	10 kHz \pm 10 dB

Bluetooth section (DNX5220BT only)

Technology	Bluetooth Ver.1.2 Certified
Frequency.....	2.402 – 2.480 GHz
Output Power ...+4 dBm (MAX), 0 dBm (AVE), Power Class 2	
Profile	
HFP (Hands Free Profile), SPP (Serial Port Profile),	
HSP (Headset Profile), A2DP (Advanced Audio	
Distribution Profile), AVRCP (Audio/Video	
Remote Control Profile), OPP (Object Push Profile),	
PBAP (Phonebook Access Profile),	
SYNC (Synchronization Profile)	

Navigation section (DNX5220BT/DNX5220 only)

Receiver.....	High-sensitivity GPS receiver
Reception Frequency	1575.42 MHz (C/A code)
Acquisition Times	
Cold.....	< 38 seconds
Factory Reset.....	< 45 seconds
(On average for a stationary receiver with a clear view of	
the sky)	
Accuracy	
Position	< 10 meters typical
Velocity.....	0.05 m/sec. RMS
Position Method	GPS
Antenna	External GPS antenna

General

Operating voltage.....	14.4 V (10.5 – 16 V allowable)
Current Consumption	15 A (Max)
Dimensions (W x H x D).....	182 x 112 x 158 mm
Operational Temperature Range	-10 $^{\circ}$ C – +60 $^{\circ}$ C
Storage Temperature Range	-20 $^{\circ}$ C – +85 $^{\circ}$ C
Weight (DNX5220BT/DNX5220)	1.90 kg
Weight (DDX5022/DDX5022Y/DDX52RY)	1.87 kg

SPECIFICATIONS (DDX5032/5032M)

Monitor section

Picture Size 6.1 inches (diagonal) wide
 136.08 mm (W) x 71.96 mm (H)
 Display System..... Transparent TN LCD panel
 Drive System TFT active matrix system
 Number of Pixels..... 336,960 (480H x 234V x RGB)
 Effective Pixels 99.99 %
 Pixel Arrangement RGB striped arrangement
 Back Lighting Cold Cathode Fluorescent Tube

DVD player section

D/A Converter..... 24 bit
 Audio Decoder ... Linear PCM/ Dolby Digital/ dts/ MP3/ WMA/ AAC
 Video Decoder..... MPEG1/ MPEG2/ MPEG4 (Divx)
 Wow & Flutter Below Measurable Limit
 Frequency Response
 Sampling frequency 96 kHz : 20 – 44,000 Hz
 Sampling frequency 48 kHz : 20 – 22,000 Hz
 Sampling frequency 44.1 kHz : 20 – 20,000 Hz
 Total Harmonic Distortion..... 0.010 % (1 kHz)
 S/N Ratio (dB)..... 98 dB (DVD-Video 96 kHz)
 Dynamic Range 98 dB (DVD-Video 96 kHz)
 Disc Format DVD-Video/ VIDEO-CD/ CD-DA
 Sampling Frequency 44.1/ 48/ 96 kHz
 Quantifying Bit Number 16/ 20/ 24 bit

USB interface section

USB Standard USB 1.1/ 2.0
 File System..... FAT 16/ 32
 Maximum Power Supply Current 500 mA
 D/A Converter..... 24 Bit
 Audio Decoder MP3/ WMA/ AAC
 Video Decoder..... MPEG1/ MPEG2/ MPEG4 (Divx)

FM tuner section

Frequency Range 87.5 MHz – 108.0 MHz (50 kHz)
 87.9 MHz – 107.9 MHz (200 kHz)
 Usable Sensitivity (S/N : 26 dB) 9.3 dBf (0.8 μ V/ 75 Ω)
 Quieting Sensitivity (S/N : 46 dB) 15.2 dBf (1.6 μ V/ 75 Ω)
 Frequency Response (\pm 3.0 dB)..... 30 Hz – 15 kHz
 S/N Ratio (dB)..... 70 dB (MONO)
 Selectivity (\pm 400 kHz) \geq 80 dB
 Stereo Separation..... 40 dB (1 kHz)

AM tuner section (Type X/Type V)

Frequency Range 531 kHz – 1611 kHz (9 kHz)
 530 kHz – 1700 kHz (10 kHz)
 Usable Sensitivity 28 dB μ

LW tuner section (Type M/Type M2)

Frequency Range (9 kHz) 153 kHz – 281 kHz
 Usable Sensitivity 45 μ V

MW tuner section (Type M/Type M2)

Frequency Range (9 kHz) 531 kHz – 1611 kHz
 Usable Sensitivity 25 μ V

Video section

Color System of External Video Input NTSC/PAL
 External Video Input Level (mini jack)..... 1 Vp-p/ 75 Ω
 External Audio Max Input Level (mini jack) 2 V/ 25 k Ω
 Video Output Level (RCA jacks) 1 Vp-p/ 75 Ω
 Audio Output Level (RCA jacks)..... 1.2 V/ 10 k Ω
 Analog RGB input..... 0.7 Vp-p/ 75 Ω

Audio section

Maximum Power (Front & Rear) 50 W x 4
 Full Bandwidth Power (Front & Rear) (at less than 1 % THD)
 22 W x 4
 Preout Level (V) 2 V/ 10 k Ω
 Preout Impedance 600 Ω
 Speaker Impedance 4 – 8 Ω
 Tone action
 Bass 100 Hz \pm 10 dB
 Middle 1 kHz \pm 10 dB
 Treble 10 kHz \pm 10 dB

General

Operating voltage 14.4 V (11 – 16 V allowable)
 Current Consumption 15 A
 Dimensions (W x H x D) 182 x 112 x 158 mm
 Operational Temperature Range -10 $^{\circ}$ C – +60 $^{\circ}$ C
 Storage Temperature Range -20 $^{\circ}$ C – +85 $^{\circ}$ C
 Weight 1.87 kg

SPECIFICATIONS (DNX5120/512EX, DDX512/5032)**Monitor section**

Picture Size 6.1 inches (diagonal) wide
 136.08 mm (W) x 71.96 mm (H)
 Display System..... Transparent TN LCD panel
 Drive System TFT active matrix system
 Number of Pixels 336,960 (480H x 234V x RGB)
 Effective Pixels 99.99 %
 Pixel Arrangement RGB striped arrangement
 Back Lighting Cold Cathode Fluorescent Tube

DVD player section

D/A Converter..... 24 bit
 Audio Decoder ... Linear PCM/ Dolby Digital/ dts/ MP3/ WMA/ AAC
 Video Decoder..... MPEG1/ MPEG2
 Wow & Flutter Below Measurable Limit
 Frequency Response
 Sampling frequency 96 kHz : 20 – 44,000 Hz
 Sampling frequency 48 kHz : 20 – 22,000 Hz
 Sampling frequency 44.1 kHz : 20 – 20,000 Hz
 Total Harmonic Distortion..... 0.010 % (1 kHz)
 S/N Ratio (dB)..... 98 dB (DVD-Video 96 kHz)
 Dynamic Range 98 dB (DVD-Video 96 kHz)
 Disc Format DVD-Video/ VIDEO-CD/ CD-DA
 Sampling Frequency 44.1/ 48/ 96 kHz
 Quantifying Bit Number 16/ 20/ 24 bit

USB interface section

USB Standard USB 1.1/ 2.0
 File System..... FAT 16/ 32
 Maximum Power Supply Current 500 mA
 D/A Converter..... 24 Bit
 Audio Decoder MP3/ WMA/ AAC
 Video Decoder..... MPEG1/ MPEG2

FM tuner section

Frequency Range (200 kHz) 87.9 MHz – 107.9 MHz
 Usable Sensitivity (S/N : 30 dB) 9.3 dBf (0.8 μ V/ 75 Ω)
 Quieting Sensitivity (S/N : 50 dB) 15.2 dBf (1.6 μ V/ 75 Ω)
 Frequency Response (\pm 3.0 dB)..... 30 Hz – 15 kHz
 S/N Ratio (dB)..... 70 dB (MONO)
 Selectivity (\pm 400 kHz) \geq 80 dB
 Stereo Separation..... 40 dB (1 kHz)

AM tuner section

Frequency Range (10 kHz) 530 kHz – 1700 kHz
 Usable Sensitivity 28 dB μ

DANGER:

Please do not look at the laser beam directly during repair or operation check.

Video section

Color System of External Video Input NTSC
 External Video Input Level (mini jack)..... 1 Vp-p/ 75 Ω
 External Audio Max Input Level (mini jack) 2 V/ 25 k Ω
 Video Output Level (RCA jacks) 1 Vp-p/ 75 Ω
 Audio Output Level (RCA jacks)..... 1.2 V/ 10 k Ω
 Analog RGB input (DDX512/DDX5032 only) ... 0.7 Vp-p/ 75 Ω

Audio section

Maximum Power (Front & Rear) 50 W x 4
 Full Bandwidth Power (Front & Rear)
 (4 Ω , 14.4 V, 1 % THD) 22 W x 4
 Preout Level (V) 2 V/ 10 k Ω
 Preout Impedance 600 Ω
 Speaker Impedance 4 – 8 Ω
 Tone action
 Bass 100 Hz \pm 10 dB
 Middle 1 kHz \pm 10 dB
 Treble 10 kHz \pm 10 dB

Navigation section (DNX5120/DNX512EX only)

Receiver..... High-sensitivity GPS receiver
 Reception Frequency 1575.42 MHz (C/A code)
 Acquisition Times
 Cold..... < 38 seconds
 Factory Reset..... < 45 seconds
 (On average for a stationary receiver with a clear view of the sky)
 Accuracy
 Position < 10 meters typical
 Velocity..... 0.05 m/sec. RMS
 Position Method GPS
 Antenna External GPS antenna

General

Operating voltage 14.4 V (11 – 16 V allowable)
 Current Consumption 15 A
 Dimensions (W x H x D) 182 x 112 x 158 mm
 7-3/16 x 4-7/16 x 6-1/4 inch
 Operational Temperature Range -10 $^{\circ}$ C – +60 $^{\circ}$ C
 Storage Temperature Range -20 $^{\circ}$ C – +85 $^{\circ}$ C
 Weight (DNX5120/DNX512EX) 1.90 kg (4.2 lbs)
 Weight (DDX512/DDX5032) 1.87 kg (4.1 lbs)

KENWOOD follows a policy of continuous advancements in development. For this reason specifications may be changed without notice.

Although the effective pixels for the liquid crystal panel is given as 99.99% or more, 0.01% of pixels may not light or may light incorrectly.

US and foreign patents licensed from Dolby Laboratories.

